

INSTRUCTION MANUAL
Power Station

PS series

PS-101A

PS-102A

PS-103A

PS-105A

PS-101AC

PS-102AC

PS-103AC

PS-105AC

HOW TO READ THIS MANUAL

Thank you for selecting the PS-101A/102A/103A/105A/101AC/102AC/103AC/105AC.

- Please read this Operator's manual carefully, before using this product.
- PS has a function to output data to a connected host computer. Command operations from a host computer can also be performed. For details, refer to "Communication manual" and ask your local dealer.
- The specifications and general appearance of the instrument are subject to change without prior notice and without obligation by TOPCON CORPORATION and may differ from those appearing in this manual.
- The content of this manual is subject to change without notice.
- Some of the diagrams shown in this manual may be simplified for easier understanding.
- This manual is protected by copyright and all rights are reserved by TOPCON CORPORATION.
- Except as permitted by Copyright law, this manual may not be copied, and no part of this manual may be reproduced in any form or by any means.
- This manual may not be modified, adapted or otherwise used for the production of derivative works.

Symbols

The following conventions are used in this manual.



: Indicates precautions and important items which should be read before operations.



: Indicates the chapter title to refer to for additional information.



: Indicates supplementary explanation.



: Indicates an explanation for a particular term or operation.

[Softkey] etc. : Indicates softkeys on the display and window dialog buttons.



{Key} etc. : Indicates keys on the operation panel.

<Screen title> etc. : Indicates screen titles.

Notes regarding manual style

- Except where stated, "PS" means PS-101A/102A/103A/105A/101AC/102AC/103AC/105AC in this manual.
- Models are described as follows.

PS-101A/102A/103A/105A	Auto tracking model
PS-101AC/102AC/103AC/105AC	Auto pointing model

- Face 2 display is available as standard or as a factory option depending on the country of purchase.
- Location of softkeys in screens used in procedures is based on the factory setting. It is possible to change the allocation of softkeys.
 Softkey allocation: "20.6 Allocating Key Functions"
- Learn basic operations in "4. PRODUCT OUTLINE" and "5. BASIC OPERATION" before you read each measurement procedure. For selecting options and inputting figures, see "5.1 Basic Key Operation".
- Measurement procedures are based on continuous measurement. Some information about procedures when other measurement options are selected can be found in "Note" ().
- KODAK is a registered trademark of Eastman Kodak Company.
- *Bluetooth*[®] is a registered trademark of Bluetooth SIG, Inc.
- Windows and Windows CE are registered trademarks of Microsoft Corporation.
- All other company and product names featured in this manual are trademarks or registered trademarks of each respective organization.



Li-ion CONTAINS Li-ion BATTERY.
MUST BE RECYCLED OR DISPOSED OF PROPERLY.

JSIMA

This is the mark of the Japan Surveying
Instruments Manufacturers Association.

CONTENTS

1. PRECAUTIONS FOR SAFE OPERATION	1
2. PRECAUTIONS	4
3. LASER SAFETY INFORMATION	7
4. PRODUCT OUTLINE	9
4.1 Parts of the Instrument	9
4.2 Mode Structure	14
4.3 <i>Bluetooth</i> Wireless Technology	15
5. BASIC OPERATION	17
5.1 Basic Key Operation	17
5.2 Display Functions	21
5.3 Inputting Characters using the Input Panel	25
5.4 Starkey Mode	26
5.5 Using the Program Selection Screen	31
6. USING THE BATTERY	32
6.1 Battery Charging	32
6.2 Installing/Removing the Battery	33
7. SETTING UP THE INSTRUMENT	35
7.1 Centering	35
7.2 Levelling	36
8. POWER ON/OFF	38
8.1 Resolving Software Issues	39
8.2 Configuring the Touch Panel	39
8.3 Powering ON/OFF from an External Instrument	40
9. CONNECTING TO EXTERNAL DEVICES	41
9.1 Wireless Communication using <i>Bluetooth</i> Technology	41
9.2 Communication between the PS and Companion Device	45
9.3 Connection via RS232C cable	46
9.4 Connecting via USB Cable	47
9.5 Inserting USB Memory	50
10. TARGET SIGHTING	51
10.1 Auto Pointing Settings	52
10.2 Auto-Pointing Function for Target Sighting	54
10.3 Manually Sighting the Target	56
11. MEASUREMENT WITH AUTO TRACKING	58
11.1 Auto Tracking Settings	58

11.2	Stating up External Link and Settings	60
11.3	Measurement with Auto Tracking	61
12.	ANGLE MEASUREMENT	64
12.1	Measuring the Horizontal Angle between Two Points (Horizontal Angle 0°)	64
12.2	Setting the Horizontal Angle to a Required Value (Horizontal Angle Hold)	65
12.3	Turning the Instrument from the Reference Angle to a Specified Angle	66
12.4	Angle measurement and Outputting the Data	67
13.	DISTANCE MEASUREMENT	68
13.1	Returned Signal Checking	68
13.2	Using the Guide Light in Distance Measurement	70
13.3	Distance and Angle Measurement	71
13.4	Distance Measurement and Outputting the Data	72
13.5	REM Measurement	73
14.	COORDINATE MEASUREMENT	75
14.1	Entering Instrument Station Data	75
14.2	Azimuth Angle Setting	76
14.3	3-D Coordinate Measurement	79
15.	RESECTION MEASUREMENT	81
15.1	Coordinate Resection Measurement	82
15.2	Height Resection Measurement	86
16.	SETTING-OUT MEASUREMENT	91
16.1	Using the Guide Light in Setting-out Measurement	91
16.2	Distance Setting-out Measurement	92
16.3	Coordinates Setting-out Measurement	96
16.4	REM Setting-out Measurement	100
17.	OFFSET MEASUREMENT	102
17.1	Offset Single-distance Measurement	102
17.2	Offset Angle Measurement	104
17.3	Offset Two-distance Measurement	106
18.	MISSING LINE MEASUREMENT	109
18.1	Measuring the Distance between 2 or more Points	109
18.2	Changing the Starting Point	111
19.	SURFACE AREA CALCULATION	113



20. CHANGING THE SETTINGS	117
20.1 Observation Conditions	117
20.2 Instrument Configuration	120
20.3 EDM Settings	122
20.4 Allocating User-defined Tabs	126
20.5 Customizing Screen Controls	129
20.6 Allocating Key Functions	131
20.7 Changing Starkey Mode Icons	134
20.8 Units	136
20.9 Changing Password	137
20.10 Restoring Default Settings	138
20.11 Date and Time	138
21. WARNING AND ERROR MESSAGES.....	139
22. CHECKS AND ADJUSTMENTS.....	142
22.1 Circular Level	142
22.2 Tilt Sensor	143
22.3 Collimation	146
22.4 Reticle	147
22.5 Image Sensor Reticle	149
22.6 Optical Plummet	151
22.7 Additive Distance Constant	152
23. POWER SUPPLY SYSTEM	154
24. PRISM SYSTEM.....	155
25. OPPTIONAL ACCESSORIES	156
26. SPECIFICATIONS.....	159
27. EXPLANATIONS	166
27.1 High Accuracy with the 360° Prism	166
27.2 Manually Indexing the Vertical Circle by Face Left, Face Right Measurement 167	
28. REGULATIONS.....	168
29. INDEX.....	172



1. PRECAUTIONS FOR SAFE OPERATION

For the safe use of the product and prevention of injury to operators and other persons as well as prevention of property damage, items which should be observed are indicated by an exclamation point within a triangle used with WARNING and CAUTION statements in this operator's manual.









The definitions of the indications are listed below. Be sure you understand them before reading the manual's main text.

Definition of Indication





 WARNING	Ignoring this indication and making an operation error could possibly result in death or serious injury to the operator.
 CAUTION	Ignoring this indication and making an operation error could possibly result in personal injury or property damage.

-  This symbol indicates items for which caution (hazard warnings inclusive) is urged. Specific details are printed in or near the symbol.
-  This symbol indicates items which are prohibited. Specific details are printed in or near the symbol.
-  This symbol indicates items which must always be performed. Specific details are printed in or near the symbol.

General













-  **Warning**
 -  Do not use the unit in areas exposed to high amounts of dust or ash, in areas where there is inadequate ventilation, or near combustible materials. An explosion could occur.
 -  Do not perform disassembly or rebuilding. Fire, electric shock, burns, or hazardous radiation exposure could result.
 -  Never look at the sun through the telescope. Loss of eyesight could result.
 -  Do not look at reflected sunlight from a prism or other reflecting object through the telescope. Loss of eyesight could result.
 -  Direct viewing of the sun using the telescope during sun observation will cause loss of eyesight. Use a solar filter (option) for sun observation.
 -  When securing the instrument in the carrying case make sure that all catches, including the side catches, are closed. Failure to do so could result in the instrument falling out while being carried, causing injury.
-  **Caution**
 -  Do not use the carrying case as a footstool. The case is slippery and unstable so a person could slip and fall off it.

1. PRECAUTIONS FOR SAFE OPERATION

-  Do not place the instrument in a case with a damaged catch, belt or handle. The case or instrument could be dropped and cause injury.
-  Do not touch the instrument or look through the telescope while the motor is in operation. Injury could result.
-  Do not wield or throw the plumb bob. A person could be injured if struck.
-  Secure handle to main unit with handle locks. Failure to properly secure the handle could result in the unit falling off while being carried, causing injury.
-  Tighten the adjustment tribrach clamp securely. Failure to properly secure the clamp could result in the tribrach falling off while being carried, causing injury.

Power Supply

Warning

-  Do not short circuit. Heat or ignition could result.
-  Do not place articles such as clothing on the battery charger while charging batteries. Sparks could be induced, leading to fire.
-  Do not use voltage other than the specified power supply voltage. Fire or electrical shock could result.
-  Do not use batteries other than those designated. An explosion could occur, or abnormal heat generated, leading to fire.
-  Do not use damaged power cords, plugs or loose outlets. Fire or electric shock could result.
-  Do not use power cords other than those designated. Fire could result.
-  Use only the specified battery charger to recharge batteries. Other chargers may be of different voltage rating or polarity, causing sparking which could lead to fire or burns.
-  Do not use the battery or charger for any other equipment or purpose. Fire or burns caused by ignition could result.
-  Do not heat or throw batteries or chargers into fire. An explosion could occur, resulting in injury.
-  To prevent shorting of the battery in storage, apply insulating tape or equivalent to the terminals. Otherwise shorting could occur resulting in fire or burns.
-  Do not use batteries or the battery charger if wet. Resultant shorting could lead to fire or burns.
-  Do not connect or disconnect power supply plugs with wet hands. Electric shock could result.



Caution



Do not touch liquid leaking from batteries. Harmful chemicals could cause burns or blisters.

Tripod



Caution



When mounting the instrument to the tripod, tighten the centering screw securely. Failure to tighten the screw properly could result in the instrument falling off the tripod, causing injury.



Tighten securely the leg fixing screws of the tripod on which the instrument is mounted. Failure to tighten the screws could result in the tripod collapsing, causing injury.



Do not carry the tripod with the tripod shoes pointed at other persons. A person could be injured if struck by the tripod shoes.



Keep hands and feet away from the tripod shoes when fixing the tripod in the ground. A hand or foot stab wound could result.



Tighten the leg fixing screws securely before carrying the tripod. Failure to tighten the screws could lead to the tripod legs extending, causing injury.

Bluetooth wireless technology



Warning



Do not use within the vicinity of hospitals. Malfunction of medical equipment could result.



Use the instrument at a distance of at least 22 cm from anyone with a cardiac pacemaker. Otherwise, the pacemaker may be adversely affected by the electromagnetic waves produced and cease to operate as normal.



Do not use onboard aircraft. The aircraft instrumentation may malfunction as a result.



Do not use within the vicinity of automatic doors, fire alarms and other devices with automatic controls as the electromagnetic waves produced may adversely affect operation resulting in an accident.

2. PRECAUTIONS

Telescope

- Aiming the telescope at the sun will cause internal damage to the instrument. Use the solar filter when observing the sun.

☞ "25. OPTIONAL ACCESSORIES"

Tribrach Clamp and Handle

- When the instrument is shipped, the tribrach clamp is held firmly in place with a locking screw to prevent the instrument from shifting on the levelling base. Before using the instrument the first time, loosen this screw with a screwdriver. And before transporting it, tighten the locking screw to fasten the tribrach clamp in place so that it will not shift on the tribrach.
- The handle of the instrument can be removed. When operating the instrument with the handle attached, always make sure that the handle is securely fixed to the instrument body with the handle locks.

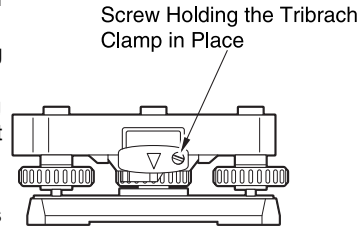

Precautions concerning water and dust resistance

The instrument conforms to IP65 specifications for waterproofing and dust resistance when battery cover, connector cap and the external interface hatch and are closed.

- Be sure to correctly attach the connector caps to protect the instrument from moisture and dust particles when the connector is not in use.
- Make sure that moisture or dust particles do not come in contact with the terminal or connectors. Operating the instrument with moisture or dust on the terminal or connectors may cause damage to the instrument.
- Make sure that the inside of the carrying case and the instrument are dry before closing the case. If moisture is trapped inside the case, it may cause the instrument to rust.
- If there is a crack or deformation in the rubber packing for the battery cover or external interface hatch, stop using and replace the packing.
- To retain the waterproof property, it is recommended that you replace the rubber packing once every two years. To replace the packing, contact your local sales representative.

The Lithium Battery

- The lithium battery is used to maintain the Calendar & Clock function. It can back up data for approximately 5 years of normal use and storage (Temperature = 20°, humidity = about 50%), but its lifetime may be shorter depending on circumstances.

The Levelling Base

- Always use the levelling base provided. During a traverse observation, it is recommended to use the same type of levelling base for the target as well for accurate observations.



Backing up data

- Data should be backed up (transferred to an external device etc.) on a regular basis to prevent data loss.

Other precautions

- Never place the instrument directly on the ground. Sand or dust may cause damage to the screw holes or the centering screw on the base plate.
- Do not perform vertical rotation of the telescope when using the lens hood, diagonal eyepiece, or solar filter. Such accessories may strike the instrument causing damage.
- Protect the instrument from heavy shocks or vibration.
- Protect the instrument from rain or drizzle with an umbrella or waterproof cover.
- Never carry the instrument on the tripod to another site.
- Turn the power off before removing the battery.
- Remove the battery before placing the instrument in its case.
- Make sure that the instrument and the protective lining of the carrying case are dry before closing the case. The case is hermetically sealed and if moisture is trapped inside, the instrument could rust.
- Consult your local dealer before using the instrument under special conditions such as long periods of continuous use or high levels of humidity. In general, special conditions are treated as being outside the scope of the product warranty.

Maintenance

- Wipe off moisture completely if the instrument gets wet during survey work.
- Always clean the instrument before returning it to the case. The lens requires special care. First, dust it off with the lens brush to remove tiny particles. Then, after providing a little condensation by breathing on the lens, wipe it with the wiping cloth.
- If the display is dirty, carefully wipe it with a soft, dry cloth. To clean other parts of the instrument or the carrying case, lightly moisten a soft cloth in a mild detergent solution. Wring out excess water until the cloth is slightly damp, then carefully wipe the surface of the unit. Do not use any alkaline cleaning solutions, alcohol, or any other organic solvents on the instrument or display.
 For temporal de-activating the touch panel, see "5.2 Display Functions", "20. CHANGING THE SETTINGS"
- Store the instrument in a dry room where the temperature remains fairly constant.
- Check the tripod for loose fit and loose screws.
- If any trouble is found on the rotatable portion, screws or optical parts (e.g. lens), contact your local dealer.
- When the instrument is not used for a long time, check it at least once every 3 months.
 "22. CHECKS AND ADJUSTMENTS"
- Every 4,000 to 5,000 hours operation in total, change grease of driving parts. Contact your local dealer for the maintenance.
- When removing the instrument from the carrying case, never pull it out by force. The empty carrying case should be closed to protect it from moisture.
- Check the instrument for proper adjustment periodically to maintain the instrument accuracy.

Exporting this product

- This product is equipped with the parts/units, and contains software/technology, which are subject to the EAR (Export Administration Regulations). Depending on countries you wish to export or bring the product to, a US export license may be required. In such a case, it is your responsibility to obtain the license. The countries requiring the license as of January 2012 are shown below. Please consult the Export Administration Regulations as they are subject to change.

North Korea
Iran
Syria
Sudan
Cuba

URL for the EAR of the US: http://www.access.gpo.gov/bis/ear/ear_data.html

Exceptions from responsibility

- The user of this product is expected to follow all operating instructions and make periodic checks (hardware only) of the product's performance.
- The manufacturer, or its representatives, assumes no responsibility for results of faulty or intentional usage or misuse including any direct, indirect, consequential damage, or loss of profits.
- The manufacturer, or its representatives, assumes no responsibility for consequential damage, or loss of profits due to any natural disaster, (earthquake, storms, floods etc.), fire, accident, or an act of a third party and/or usage under unusual conditions.
- The manufacturer, or its representatives, assumes no responsibility for any damage (change of data, loss of data, loss of profits, an interruption of business etc.) caused by use of the product or an unusable product.
- The manufacturer, or its representatives, assumes no responsibility for any damage, and loss of profits caused by usage different to that explained in the operator's manual.
- The manufacturer, or its representatives, assumes no responsibility for damage caused by incorrect operation, or action resulting from connecting to other products.

3. LASER SAFETY INFORMATION

The instrument is classified as the following class of Laser Product according to IEC Standard Publication 60825-1 Ed.2.0: 2007 and United States Government Code of Federal Regulation FDA CDRH 21CFR Part 1040.10 and 1040.11 (Complies with FDA performance standards for laser products except for deviations pursuant to Laser Notice No.50, dated June 24, 2007.)

- EDM device in objective lens: Class 3R Laser Product
(When using prism or reflective sheet as target)Class 1 Laser Product

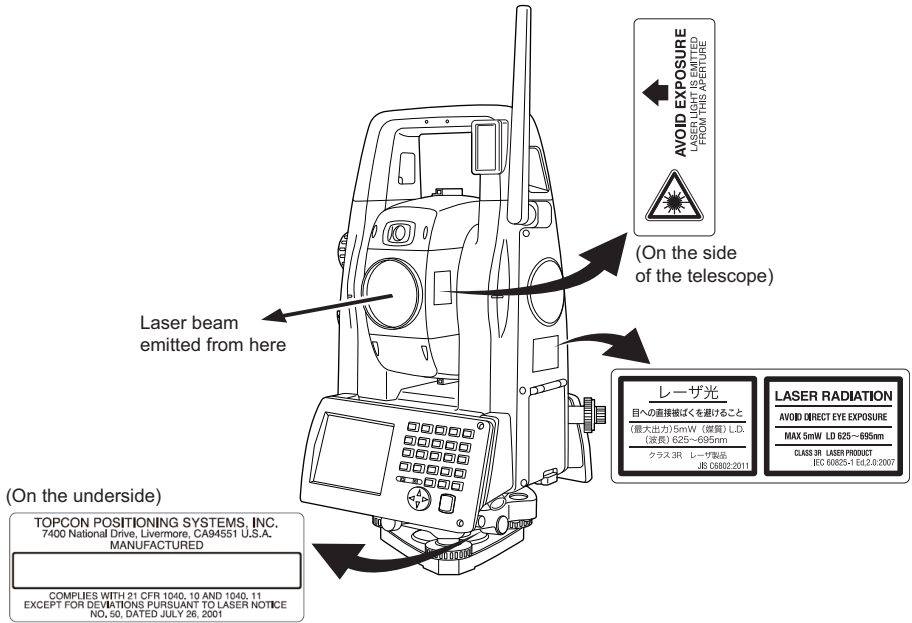

- EDM device is classified as Class 3R Laser Product when reflectorless measurement is selected. When the prism or reflective sheet is selected as target, the output is equivalent to the safer class 1.

Warning

- Use of controls or adjustments or performance of procedures other than those specified herein may result in hazardous radiation exposure.
- Follow the safety instructions on the labels attached to the instrument as well as in this manual to ensure safe use of this laser product.
- Never point the laser beam at another person. If the laser beam strikes skin or an eye, it could cause serious injury.
- Do not look directly into the laser beam source or guide light source. Doing so could cause permanent eye damage.
- Do not stare at the laser beam. Doing so could cause permanent eye damage.
- If an eye injury is caused by exposure to the laser beam, seek immediate medical attention from a licensed ophthalmologist.

- Never look at the laser beam through a telescope, binoculars or other optical instruments. Doing so could cause permanent eye damage.
- Sight the target so that the laser beam does not stray from them.

Caution







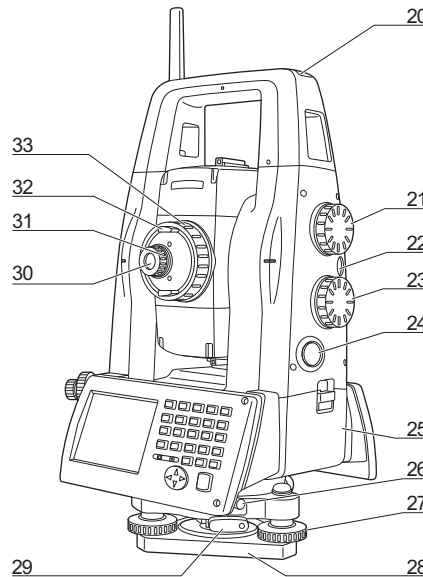
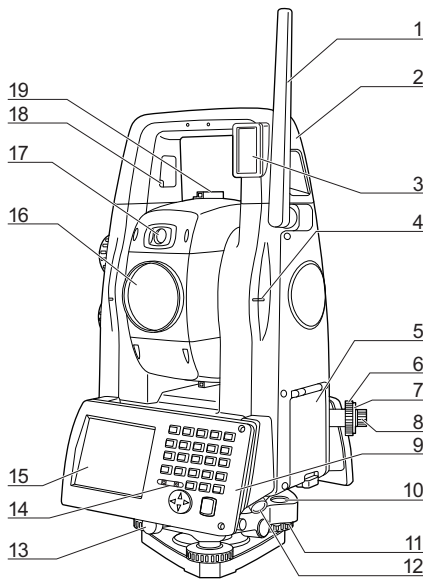

- Perform checks at start of work and periodic checks and adjustments with the laser beam emitted under normal conditions.
- When the instrument is not being used, turn off the power and replace the lens cap.
- When disposing of the instrument, destroy the battery connector so that the laser beam cannot be emitted.
- Operate the instrument with due caution to avoid injuries that may be caused by the laser beam unintentionally striking a person in the eye. Avoid setting the instrument at heights at which the path of the laser beam may strike pedestrians or drivers at head height.
- Never point the laser beam at mirrors, windows or surfaces that are highly reflective. The reflected laser beam could cause serious injury.
- Only those who have been received training as per the following items shall use this product.
 - Read the Operator's manual for usage procedures for this product.
 - Hazardous protection procedures (read this chapter).
 - Requisite protective gear (read this chapter).
 - Accident reporting procedures (stipulate procedures beforehand for transporting the injured and contacting physicians in case there are laser induced injuries).
- Persons working within the range of the laser beam are advised to wear eye protection which corresponds to the laser wavelength of the instrument being used
- Areas in which the lasers are used should be posted with laser warning notices.
- When using the laser-pointer function, be sure to turn OFF the output laser after distance measurement is completed. Even if distance measurement is canceled, the laser-pointer function is still operating and the laser beam continues to be emitted.

4. PRODUCT OUTLINE

4.1 Parts of the Instrument

Parts and functions of the instrument



- 1 Wireless antenna
- 2 Handle
- 3 Beam detector for Remote Controller
- 4  Instrument height mark
- 5 External interface hatch
 "9. CONNECTING TO EXTERNAL DEVICES"
- 6 Optical plummet focussing ring
- 7 Optical plummet reticle cover
- 8 Optical plummet eyepiece
- 9 Keyboard
 "5.2 Display Functions"
- 10 Circular level
- 11 Circular level adjusting screws
- 12 Serial / External power source connector
- 13 Levelling base locking screw
- 14 Luminance sensor
- 15 Display unit
- 16 Objective lens
(Includes " Laser-pointer function")
- 17 Guide light
- 18 Handle locking screw
- 19  Sighting collimator
- 20 Tubular compass slot
- 21  Vertical Jog
- 22 Power key
- 23  Horizontal Jog
- 24  Trigger key
- 25 Battery cover
- 26 Stylus (pen)
- 27 Levelling foot screw
- 28 Base plate
- 29 Tribrach clamp
- 30 Telescope eyepiece
- 31 Telescope eyepiece screw
- 32 Telescope knob
- 33 Telescope focussing ring



Instrument height mark

The height of the instrument is as follows:

- 196mm (from tribrach mounting surface to this mark)
- 236mm (from tribrach dish to this mark)

"Instrument height" is input when setting instrument station data and is the height from the surveying point (where the instrument is mounted) to this mark.



Laser-pointer function

A target can be sighted with a red laser beam in dark locations without the use of the telescope.



Guide light

Setting-out measurement etc. can be carried out effectively using the guide light. The guide light is composed of a light that is divided into green and red sections. A poleman can ascertain the present position by checking the guide light color.

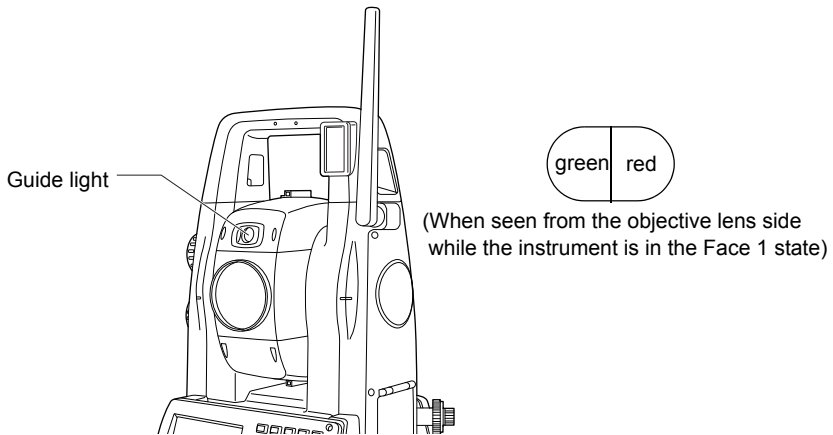

● Guide light status

Light status	Meaning
Slow flashing (Red and green simultaneously)	Waiting
	Search error (error screen only)
Fast flashing (Red and green simultaneously)	Searching in progress
	Measuring (continuous measurement)
	Returned signal checking in progress
	Auto Tracking in progress (Auto Tracking model only)
Green and red alternate flashing	Auto Tracking in predicted direction (Auto Tracking model only)
	Distance measurement error (no signal, sighting error)
	"Prism wait"

☞ "13.2 Using the Guide Light in Distance Measurement", "16.1 Using the Guide Light in Setting-out Measurement"



Instrument height mark

The height of the instrument is as follows:

- 196mm (from tribrach mounting surface to this mark)
- 236mm (from tribrach dish to this mark)

"Instrument height" is input when setting instrument station data and is the height from the surveying point (where the instrument is mounted) to this mark.



Laser-pointer function

A target can be sighted with a red laser beam in dark locations without the use of the telescope.



Guide light

Setting-out measurement etc. can be carried out effectively using the guide light. The guide light is composed of a light that is divided into green and red sections. A poleman can ascertain the present position by checking the guide light color.

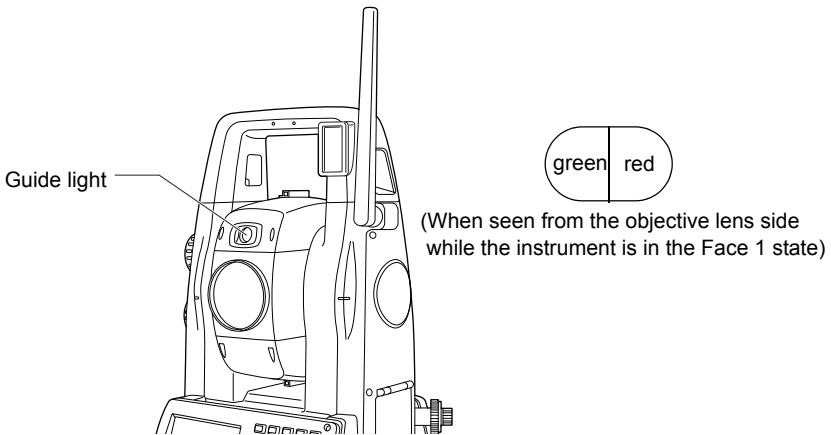

● Guide light status

Light status	Meaning
Slow flashing (Red and green simultaneously)	Waiting
	Search error (error screen only)
Fast flashing (Red and green simultaneously)	Searching in progress
	Measuring (continuous measurement)
	Returned signal checking in progress
	Auto Tracking in progress (Auto Tracking model only)
Green and red alternate flashing	Auto Tracking in predicted direction (Auto Tracking model only)
	Distance measurement error (no signal, sighting error)
	"Prism wait"

☞ "13.2 Using the Guide Light in Distance Measurement", "16.1 Using the Guide Light in Setting-out Measurement"



Vertical and Horizontal Jogs

The instrument and telescope can be rotated manually by hand or, for more precise adjustments, by turning the vertical and horizontal Jogs.

The faster the Jogs are turned, the faster the instrument and telescope rotate.

 "10.1 Auto Pointing Settings" step 3



Trigger key

When the Trigger key is pressed the instrument carries out the operation indicated by the softkey in bold type on the screen. This allows the user to continue operation without having to return to the display to press softkeys.



Sighting collimator

Use sighting collimator to aim the instrument in the direction of the measurement point.

Turn the instrument until the apex of the triangle in the sighting collimator is aligned with the target. A circle surrounds the triangle to make it easier to locate.

Wireless antenna

When performing wireless communications, the antenna must be directed towards the zenith.



Handle the antenna with care and be aware of the following points when operating.

- An extended antenna may be damaged if struck during operation.
- Do not turn the antenna incorrect direction.
- Always stow the antenna in a downward direction when the instrument is not in use.

Detaching/attaching the Handle

The carrying handle can be removed from the instrument. To remove it, loosen the handle rocking screws.



- To remove the handle, hold both sides of the handle and lift it straight above. If you hold the handle by one hand or incline it, the terminal attached on the handle may be damaged.
- Detach the handle if the prism is located at the zenith.

To attach the handle, position the handle as shown, tighten the 2 handle rocking screws.

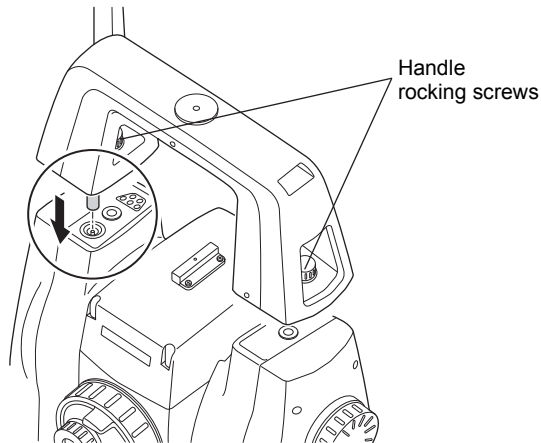

Beam detector for Remote Controller (Handle)



- Never touch the beam detector. The ability of the system to perform Turning may be adversely affected. If the beam detector is dirty, carefully wipe it with the wiping cloth.

Detaching the instrument from the levelling base

1. Loosen the levelling base locking screw by turning 2 or 3 rotations in the counterclockwise direction.
2. Turn the tribrach clamp counterclockwise to loosen.
3. Lift the instrument to detach.

Attaching the instrument to the levelling base

1. Check that the levelling base locking screw has been loosened.
2. Align (1) and (2) and lower the instrument onto the levelling base.
3. Turn the tribrach clamp clockwise to tighten.
4. Turn the levelling base locking screw clockwise to tighten.

Note

- Always fully tighten the levelling base locking screw to reduce adverse effects of motor operation on accuracy and ensure optimal results.

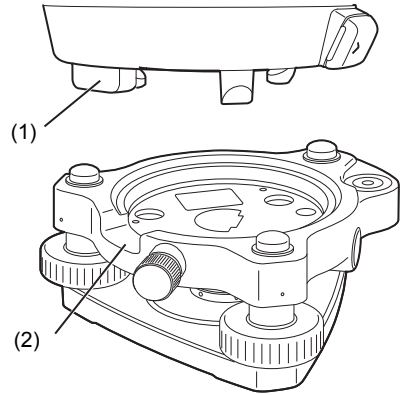

4.2 Mode Structure

The diagram below describes the different modes of the instrument and key operations for navigating between them.

● Basic mode

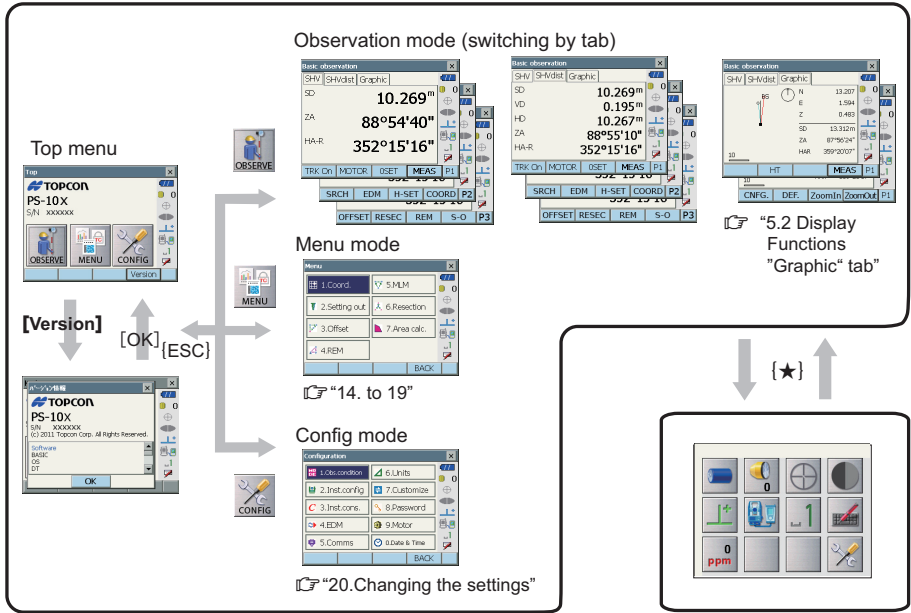

● Program mode

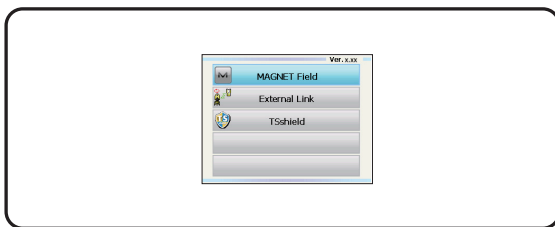

● Starkey mode

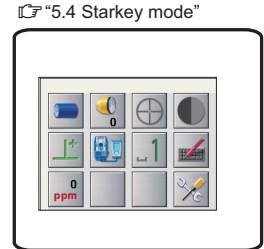

- Switching between modes is not possible during distance measurement.
- Do not switch between modes by **{PRG}** or not turn OFF the power during displaying the message "Executing program mode".

4.3 Bluetooth Wireless Technology



- *Bluetooth* communication is only possible with instruments incorporating the *Bluetooth* module.
- Use of this technology must be authorized according to telecommunications regulations of the country where the instrument is being used. Contact your local dealer in advance.
 "28. REGULATIONS"
- TOPCON CORPORATION is not liable for the content of any transmission nor any content related thereto. When communicating important data, run tests beforehand to ascertain that communication is operating normally.
- Do not divulge the content of any transmission to any third party.

Radio interference when using *Bluetooth* technology

Bluetooth communication with the PS uses the 2.4 GHz frequency band. This is the same band used by the devices described below.

- Industrial, scientific, and medical (ISM) equipment such as microwaves and pacemakers.
- portable premises radio equipment (license required) used in factory production lines etc.
- portable specified low-power radio equipment (license-exempt)
- IEEE802.11b/IEEE802.11g standard wireless LAN devices

The above devices use the same frequency band as *Bluetooth* communications. As a result, using the PS within proximity to the above devices may result in interference causing communication failure or reduction of transmission speed.

Although a radio station license is not required for this instrument, bear in mind the following points when using *Bluetooth* technology for communication.

- Regarding portable premises radio equipment and portable specified low-power radio equipment:
 - Before starting transmission, check that operation will not take place within the vicinity of portable premises radio equipment or specified low-power radio equipment.
 - In the case that the instrument causes radio interference with portable premises radio equipment, terminate the connection immediately and take measures to prevent further interference (e.g. connect using an interface cable).
 - In the case that the instrument causes radio interference with portable specified low-power radio equipment, contact your local dealer.
- When using the PS in proximity to IEEE802.11b or IEEE802.11g standard wireless LAN devices, turn off all devices not being used.
 - Interference may result, causing transmission speed to slow or even disrupting the connection completely. Turn off all devices not being used.
- Do not use the PS in proximity to microwaves.
 - Microwave ovens can cause significant interference resulting in communication failure. Perform communication at a distance of 3m or more from microwave ovens.
- Refrain from using the PS in proximity to televisions and radios.

- Televisions and radios use a different frequency band to *Bluetooth* communications. However, even if the PS is used within proximity to the above equipment with no adverse effects with regard to *Bluetooth* communication, moving a *Bluetooth* compatible device (including the PS) closer to said equipment may result in electronic noise in sound or images, adversely affecting the performance of televisions and radios.

Precautions regarding transmission

- For best results
 - The usable range becomes shorter when obstacles block the line of sight, or devices such as PDAs or computers are used. Wood, glass and plastic will not impede communication but the usable range becomes shorter. Moreover, wood, glass and plastic containing metal frames, plates, foil and other heat shielding elements as well as coatings containing metallic powders may adversely affect *Bluetooth* communication and concrete, reinforced concrete, and metal will render it impossible.
 - Use a vinyl or plastic cover to protect the instrument from rain and moisture. Metallic materials should not be used.
 - The direction of the *Bluetooth* antenna can have adverse effects upon usable range.
- Reduced range due to atmospheric conditions
 - The radio waves used by the PS may be absorbed or scattered by rain, fog, and moisture from the human body with the limit of usable range becoming lower as a result. Similarly, usable range may also shorten when performing communication in wooded areas. Moreover, as wireless devices lose signal strength when close to the ground, perform communication at as high a position as possible.

5. BASIC OPERATION

Learn basic key operations here before you read each measurement procedure.

5.1 Basic Key Operation

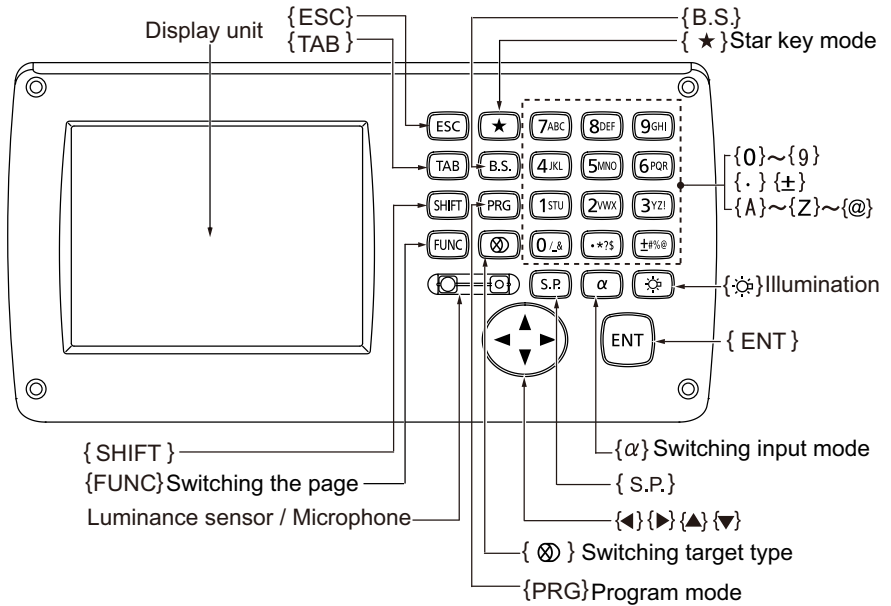

- **Power ON/OFF**

☞ "8. POWER ON/OFF"

- **Lighting up the reticle/keys and selecting screen backlight brightness**

{☀}	Switches the reticle illumination and key light On/Off (When Key light is On, backlight brightness goes down)
-----	---

☞ Brightness level: "20.2 Instrument Configuration"

- **Switching to Starkey mode**

{★}	Switches to Starkey mode / basic mode
-----	---------------------------------------

☞ "5.4 Starkey Mode"

● **Switching to Program mode**

{PRG}	Switches to program mode / basic mode
-------	---------------------------------------



- Do not switch between modes by **{PRG}** or not turn OFF the power during displaying the message "Executing program mode".

● **Switching target type**

{}	Switches between target types Prism/360° Prism/Sheet/N-prism (reflectorless)
----	---

"20.3 EDM Settings"



- Changes can also be made by tapping the icon on status bar or in Starkey mode.
 "5.2 Display Functions", "5.4 Starkey Mode"

● **Switching the Laser-pointer/Guide light ON/OFF**

{} (Press and hold until a beep sounds)	Turn ON/OFF the laser-pointer/guide light
---	---



- Changes can also be made by tapping the icon on status bar or in Starkey mode.
 "5.2 Display Functions", "5.4 Starkey Mode"

● **Switching the page**

{FUNC}	Toggle between Observation mode screen pages
--------	--

● **Inputting letters/figures**

{α}	Switch between numerals and alphabetic characters
{SHIFT} + {1} to {9}	In alphabetic characters mode, switch between lowercase characters and upper case characters each time
{SHIFT} (Press and hold)	In alphabetic characters mode, switch between lowercase characters and upper case characters
{SHIFT} + {α}	Display/hide <Input Panel>
{0} to {9}	Input numeral or symbol printed above the key (during numeric input mode) Input alphabetic character in the order they are listed (in alphabetic input mode)
{.}	Input a decimal point (during numeric input mode) Input code (in alphabetic input mode)
{±}	Input a plus or minus sign (during numeric input mode) Input code (in alphabetic input mode)

{ESC}	Cancel the input data
{TAB}	Shift to the next item
{B.S.}	Delete a character on the left.
{S.P.}	Input a blank space (increments by 1 when setting the date and time)
{◀}/▶}	Move the cursor left/right
{▲}/▼}	Move the cursor up/down
{ENT}	Select/accept input word/value

☞ Inputting rule and inputting special characters: "5.3 Inputting Characters using the Input Panel"

● Selecting options

{▲}/▼}	Move the cursor/selection item up/down
{◀}/▶}	Move the cursor/selection item left/right or select other option
{TAB}	Shift to the next item
{S.P.}	Display other options
{ENT}	Select/accept the option

● Selecting tabs

{▲}/▼}	Move tab/cursor in tab up/down
{◀}/▶}	Display next tab at left/right

☞ Tabs: "5.2 Display Functions"

● Others

{ESC}	Return to previous screen
-------	---------------------------

Example: Entering "computer" (lower case) as the name of a new device

1. Tap the input mode icon in the status bar (second from bottom) until "_a" is displayed.



- Press **{7}** three times.
"c" is displayed.



- Press **{5}** three times.
"o" is displayed.



- Press **▶**.
Press **{5}**. "m" is displayed.



- Continue to input letters. Press **{ENT}** to complete inputting.

5.2 Display Functions

Screens can be selected/operated using the keys on the keyboard or the touch panel. The touch panel can be operated using either the stylus pen provided or your fingers.

It is also possible to de-activate the touch panel temporarily.

 "20. CHANGING THE SETTINGS"



- Do not scratch the display or use any sharp implement other than the stylus pen to operate the touch panel.

Using the stylus

The stylus pen can be used to select menus and buttons on the screen and operate the scroll bar.

Temporarily de-activating the touch panel

The touch panel can be temporarily de-activated. This is especially useful when cleaning the display. To de-activate, tap  on the status bar. <Touch panel temporarily de-activated> is displayed.

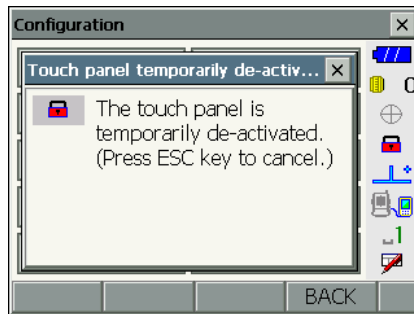

The touch panel cannot be operated while the above message is displayed. Press **{ESC}** to cancel the message and re-activate the touch panel.

Displaying and operating screens

- To close a screen, tap the cross in the top right corner, or press **{ESC}**.
- Tabs, softkey allocations, displayed tab items, and character sizes can all be changed in accordance with user preferences.

 "20. CHANGING THE SETTINGS"

Top menu

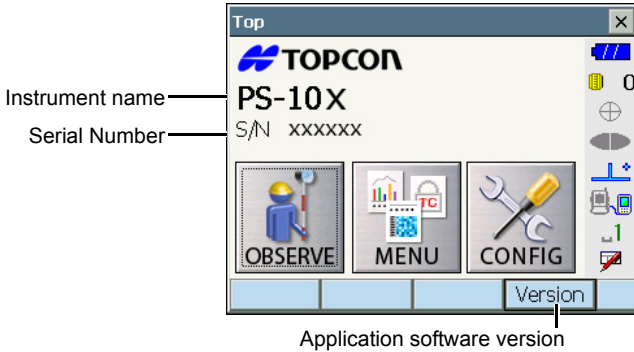

Observation mode screen

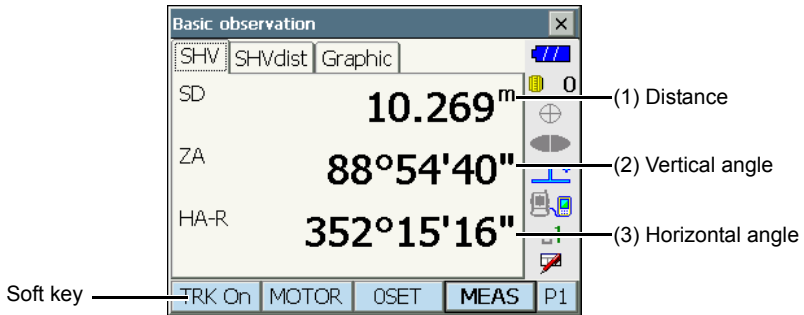

(1) Distance

Horizontal distance and height difference are also displayed in "SHVdist" tab.
Displayed items in "SHV" tab can be changed.

"20.1 Observation Conditions"

(2) Vertical angle

The Vertical angle display can be switched between Zenith ($Z=0^\circ$)/Horiz ($H=0^\circ$)/Horiz ($H=\pm 90^\circ$)
To switch vertical angle/slope in %, press **[ZA/%]** when allocated to the Observation mode screen.
The capitalized letter in the softkey indicates the currently selected mode.

Changing display: "20.1 Observation Conditions", allocating **[ZA/%]**: "20.6 Allocating Key Functions"

(3) Horizontal angle

Press **[R/L]** when allocated to the Observation mode screen to switch the display status. The capitalized letter in the softkey indicates the currently selected mode.

HA-R: Horizontal angle right

HA-L: Horizontal angle left

Allocating **[R/L]**: "20.6 Allocating Key Functions"

Input screen/configuration screen

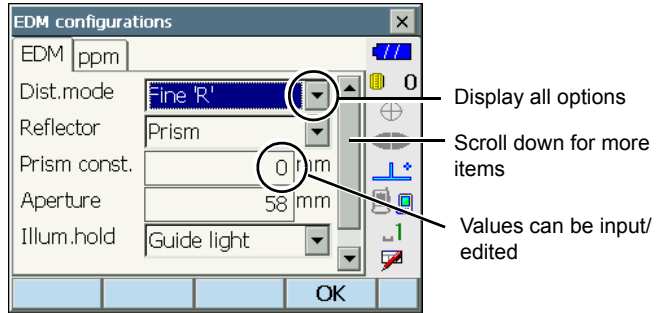

"Graphic" tab

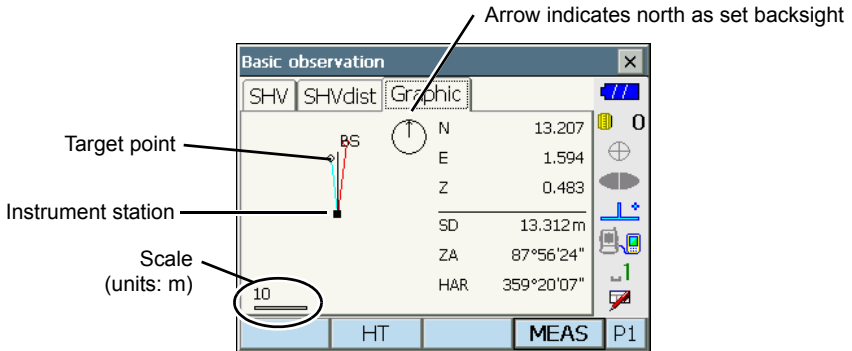

The "Graphic" tab display can be modified using the softkeys in the second page.

[CNFG] : In <Graphic configuration> the user can specify the orientation of the "graphic" tab display and which point, target or station, to set at the center of the display.

[DEF.] : Returns to the original orientation display.

[ZoomIn] : Zooms in.

[ZoomOut] : Zooms out.

Selecting menus

To select a menu, tap the touch panel or press the relevant number key.

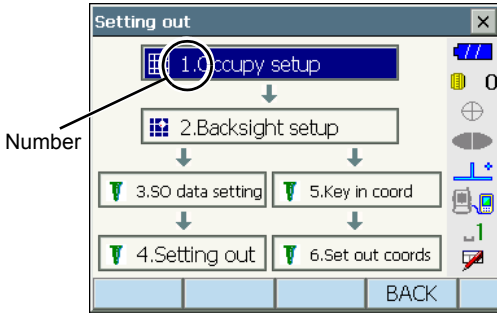

Status bar

Indicates the current status of the instrument.

Tapping icons will switch between the relevant options for that item.

Tapping and holding will display a list of all available options for that item and, in certain cases, a link to the configuration screen for that item.

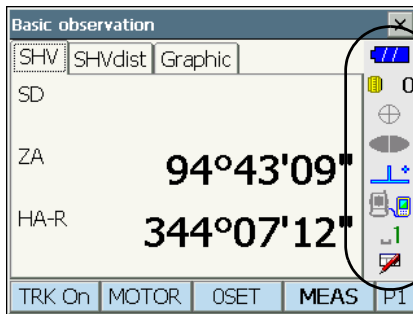

Status bar

Allocation of the icons of the status bar corresponds with that of Starkey mode.

☞ About icons: "5.4 Starkey Mode"





- When the instrument is powered OFF while displaying a list of available options, resume function will be canceled. When power is back ON, the instrument will be reset.

☞ "8. POWER ON/OFF" ☐ Resume function"

5.3 Inputting Characters using the Input Panel

To display <Input Panel>, tap  of status bar/Starkey mode or while pressing {SHIFT} press {α}. This keyboard can be used to input numeric and alphabetic characters as well as symbols. Tap the icon again to close.

Note

- When <Input Panel> is covering the  icon of the status bar, use the stylus pen to drag the input panel to another part of the screen so that you can access the  icon.

Input panel

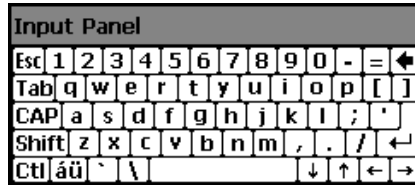

- Esc : Deletes all input characters
- Tab : Moves the cursor to the next text box
- CAP : Alternates between upper and lower case alphabetic characters and numbers/symbols
- Shift : Alternates between upper and lower case alphabetic characters and numbers/symbols. Is canceled after inputting a single character.
- Ctl : No function
- Del/↵ : Delete the character to the left/right or deletes the entire text in the active section
- ← → : Move the cursor left/right
- ENT : Accept input characters
- Space : Input a blank space
- áü : Accesses further Latin/Germanic characters/symbols. Is canceled after inputting a single character.

5.4 Starkey Mode

Via Starkey mode, you can jump from each basic mode screen to the screen of checking/changing the various settings directly. Press starkey { ★ } to enter Starkey mode. Each icon can be tapped or pressed and hold in the same way with status bar.

- 12 icons allocated in Starkey mode and the above 8 icons correspond with that status bar
- Allocation of the icons can be changed.

Changing allocation of Starkey mode: "20.7 Changing Starkey Mode Icons"

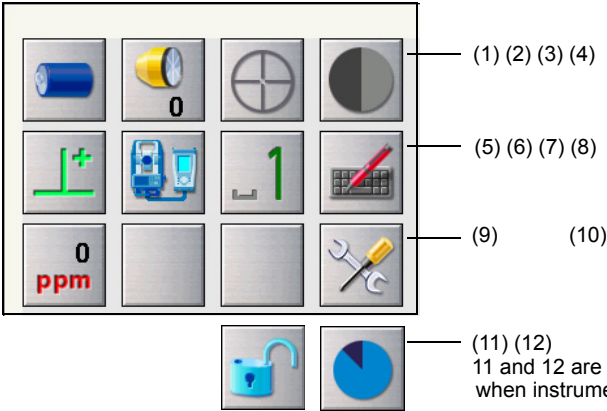

11 and 12 are not allocated when instrument was shipped.

Indicates the current status of the instrument.

Tapping icons will switch between the relevant options for that item. Tapping and holding will display a list of all available options for that item and, in certain cases, a link to the configuration screen for that item. (The numbers correspond to above icons).







(1) Battery icon

Remaining battery power indicator and configuration of auto-power function (BDC70/external battery BT-73Q, Temperature = 20°C, EDM on).

The remaining battery power displayed when distance measurement is in progress may differ to that displayed at other times.





- : Level 3 Full power
- : Level 2 Plenty of power remains
- : Level 1 Half or less power remains
- : Level 0 Little power remains Prepare a replacement battery. (Flashes red and black)
- : No power Stop operation and charge the battery. (Red display in the center of the screen)
 "6.1 Battery Charging"

When using external battery

-  : Level 3 Full power
 -  : Level 2 Plenty of power remains
 -  : Level 1 Half or less power remains
 -  : Level 0 Little power remains. Prepare a replacement battery.
 -  : No power Stop operation and charge the battery.
-  "6.1 Battery Charging"

(2) Target type icon

Selection of target type and configuration of prism constant correction value.



<input checked="" type="radio"/> Prism 0mm		0	: Prism (0mm)
<input type="radio"/> 360°Prism -7mm		-7	: 360° prism (-7mm)
<input type="radio"/> Sheet 0mm		0	: Sheet (0mm)
<input type="radio"/> N-Prism			: N-Prism
Go to EDM Config.			

Target information can be edited/recorded in <Reflector setting>.







 "20.3 EDM Settings PROCEDURE Recording and editing target information"

(3) Motor icon

Configuration of Auto Pointing/Auto Tracking status. The display may change slightly depending on the target type selected. Auto Tracking items are only relevant to Auto Tracking models and are not available for Auto Pointing models.



<input checked="" type="radio"/> Track			: Auto Tracking ON
<input type="radio"/> Search			: Auto Pointing ON
<input type="radio"/> None			: Both Auto Tracking and Auto Pointing OFF
TRK On			
: Start Auto Tracking. "AT Off" is displayed when performing Auto Tracking or when in "Prism wait" status. Tap to quit Auto Tracking.			
Search			
: Begin searching			
INV			
: Rotates the instrument 180°			
Go to Motor config.			

One of the following icons will be displayed while the motor is in operation to indicate the current status of the instrument.

-  : Rotating
-  : Rotating at fixed velocity
-  : Searching/Search after target lost during Auto Tracking
-  : Auto Tracking in progress
-  : Auto Tracking idle (when Auto Tracking set)
-  : Auto Tracking in predicted direction
-  : Waiting for prism during Auto Tracking

 ""11.3 Measurement with Auto Tracking"  Lost Prism"

Note

- Auto Tracking and Auto Pointing cannot be performed when "Reflectorless" has been selected as the target type.  will be displayed. Auto Tracking cannot be performed when "Sheet" has been selected as the target type.  will be displayed





- An arrow indicating turn direction will be displayed when the instrument is rotating at a fixed velocity.

 "12.3 Turning the Instrument from the Reference Angle to a Specified Angle"

(4) Laser-pointer/guide light icon

Configuration of laser-pointer/guide light status.

 Switching the laser-pointer/guide light ON/OFF: "5.1 Basic Key Operation"



Guide light: On 	: Guide light ON
● Guide light: Off 	: Guide light OFF
Laser-pointer: On 	: Laser-pointer ON
Laser-pointer: Off 	: Laser-pointer OFF
To EDM config.	

Note

- The laser-pointer will be automatically switched OFF during distance measurement.

(5) Tilt angle compensation icon

The vertical and horizontal angles are automatically compensated for small tilt errors using the dual-axis tilt sensor. This icon displays the status of this function.



Go to Tilt screen	
● Tilt crn: H,V 	: Horizontal and vertical tilt angles compensated (blue)
Tilt crn: No 	: No compensation
Tilt crn: V 	: Only vertical tilt angle compensated (green)
Go to Obs.conditions	

Note



-  is displayed when the instrument is out of level.

(6) Communication status with external devices icon

Selection and configuration of communication status with external devices. This icon is not displayed in Program mode.

● Serial port 	: Connection via RS232C cable
Bluetooth - Master 	: Connection via <i>Bluetooth</i> wireless technology (PS set as "Master" device) (blue antenna)
Bluetooth - Slave 	: Connection via <i>Bluetooth</i> wireless technology (PS set as "Slave" device) (green antenna)
Go to Comms Setup	

Note

- When *Bluetooth* communication is selected (PS set as "Master" device) a connection can be initiated/canceled by tapping  / .

Connection status to external devices is displayed as follows.

i) Connection via *Bluetooth* wireless technology

When PS is set as the "Master" device the antenna icon is blue. When the PS is set as the "Slave" device the antenna icon is green.



: Connecting



: Canceling connection



: (Antenna is moving) Inquiring about other *Bluetooth* devices





: (Antenna is stationary) Communication settings in progress/Preparing for communication (Instrument just powered ON or just switched to "Slave")



: Connection error (icon flashes) (the color depends on the setting)

ii) : Connection via RS232C cable



- An arrow (e.g.  / ) is displayed to indicate that data transmission is in progress. A red arrow indicates that data transmission has failed and data needs to be sent again.

(7) Input mode icon

Selection of input mode

_1	Inputting numbers and symbols
_a	Inputting lower case alphabetic characters
_A	Inputting upper case alphabetic characters

 "5.3 Inputting Characters using the Input Panel ● Inputting letters/figures"

(8) Input panel icon

 "5.3 Inputting Characters using the Input Panel"

(9) PPM setting icon

Current atmospheric correction factor setting is displayed.
Configuration of EDM.

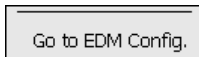

(10) Config mode icon

Switch to Config mode.

 "20. CHANGING THE SETTINGS"

(11) Touch panel icon

 "20.7 Changing Starkey Mode Icons"

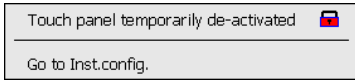

:Touch panel temporarily de-activated.

Note

- This icon cannot be operated during distance measurement, or during data transmission.

(12) Disk usage icon

Tap and hold disk icon in the status bar to check the detail of the disk usage.

 "20.7 Changing Starkey Mode Icons"



- : Less than 20%
- : 20 to 50%
- : More than 50%

Internal disk	
Used space	???? KB
Free space	???? KB
Capacity	???? KB
Removable Disk	
Used space	???? KB
Free space	???? KB
Capacity	???? KB

Internal Disk

- Used space : Usage space of disk capacity of the instrument
- Free space : Free space of disk capacity of the instrument
- Capacity : Disk capacity of the instrument

Removable Disk

- Used space : Usage space of disk capacity of the external disk connected to the instrument
- Free space : Free space of disk capacity of the external disk connected to the instrument
- Capacity : Disk capacity of the external disk connected to the instrument



- "Removable Disk" is displayed only when an external disk is connected to the instrument.

5.5 Using the Program Selection Screen

The program selection screen displays a list of all programs installed on the instrument. Each screen page contains a maximum of 5 program icons. When multiple screen pages exist, navigating between pages is possible using the arrows that appear at the left/right of the screen.

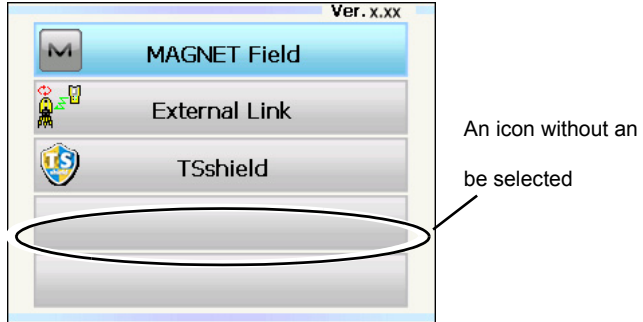

Note

- Start up External Link when communicating with a particular data collector.
 - Starting up External Link and communication settings: "11.2 Stating up External Link and Settings"

Navigating between pages

The previous/next screen page can be displayed by pressing {▲}/{▼}/{▶}/{◀}, or that appear at the left/right of the screen.



6. USING THE BATTERY

6.1 Battery Charging

The battery was not charged at the factory. Charge the battery fully before using the instrument.



- The charger will become rather hot during use. This is normal.
- Do not use to charge batteries other than those specified.
- The charger is for indoor use only. Do not use outdoors.
- Batteries cannot be charged, even when the charging lamp is flashing, when the temperature is outside the charging temperature range.
- Remove batteries from the charger before putting into storage.
- When not in use, disconnect the power cable plug from the wall outlet.
- Store the battery in a dry room where the temperature is within the following ranges. For long-term storage, the battery should be charged at least once every six months.

Storage period	Temperature range
1 week or less	-20 to 50°C
1 week to 1 month	-20 to 45°C
1 month to 6 months	-20 to 40°C
6 months to 1 year	-20 to 35°C

- Batteries generate power using a chemical reaction and as a result have a limited lifetime. Even when in storage and not used for long periods, battery capacity deteriorates with the passage of time. This may result in the operating time of the battery shortening despite having been charged correctly. In this event, a new battery is required.

PROCEDURE

1. Connect the power cable to the charger and plug the charger into the wall outlet.
2. Mount the battery in the charger by matching the grooves on the battery with the guides on the charger.

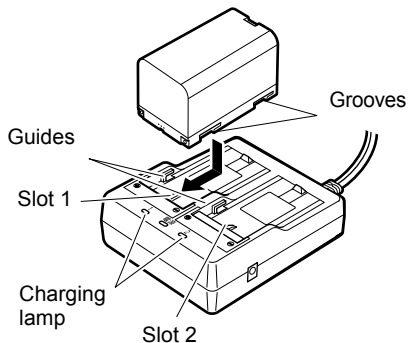

3. When charging starts, the lamp starts blinking.
4. The lamp lights when charging is finished.

- Remove the battery and unplug the charger.

Note

- Slots 1 and 2:
The charger starts charging the battery mounted first. If you place two batteries in the charger, the battery in slot 1 is charged first, and then the battery in slot 2. (☞ step 2)
- Charging lamp:
The charging lamp is off when the charger is outside the charging temperature range or when the battery is mounted incorrectly. If the lamp is still off after the charger falls within its charging temperature range and the battery is mounted again, contact your local dealer. (☞ steps 2 and 3)
- Charging time per battery (at 25°C):
BDC70: about 5.5 hours

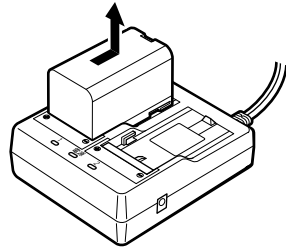

6.2 Installing/Removing the Battery

Mount the charged battery.

☞ Type of power source: "23. Power Supply System"



- Use the attached battery (BDC70).
- Before removing the battery, turn off the power to the instrument. If the battery is removed while the power is switched on, a warm boot may occur. File and folder data may be lost as a result.
- Do not open the battery cover while the power is on.
- Do not damage the projected sensor inside the battery cover. Also, be careful not to shut the battery cover on your fingers.
- When installing/removing the battery, make sure that moisture or dust particles do not come in contact with the inside of the instrument.
- Remove batteries from the surveying instrument or charger before putting into storage.

PROCEDURE Mounting the battery

- Slide down the catch on the battery cover to open.

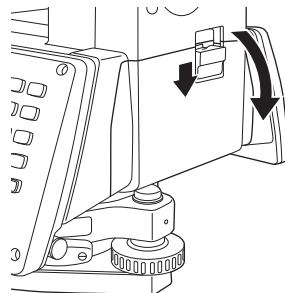

2. Checking the terminal side on the battery, insert the battery as shown.



- Do not insert the battery inclined. Doing so may damage the instrument or battery terminals.
3. Close the battery cover. A click is heard when the cover is secure.

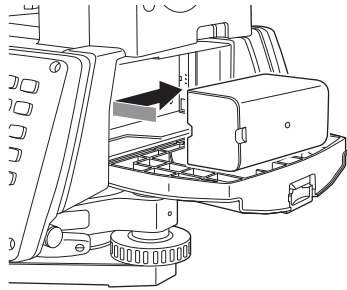

7. SETTING UP THE INSTRUMENT



- Mount the battery in the instrument before performing this operation because the instrument will tilt slightly if the battery is mounted after levelling.

7.1 Centering

PROCEDURE Centering with the optical plummet eyepiece

1. Make sure the legs are spaced at equal intervals and the head is approximately level. Set the tripod so that the head is positioned over the survey point. Make sure the tripod shoes are firmly fixed in the ground.

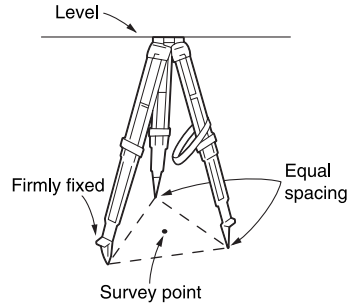

2. Place the instrument on the tripod head. Supporting it with one hand, tighten the centering screw on the bottom of the unit to make sure it is secured to the tripod.

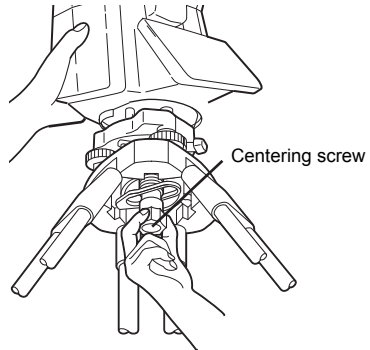

3. Looking through the optical plummet eyepiece, turn the optical plummet eyepiece to focus on the reticle. Turn the optical plummet focussing ring to focus on the survey point.

Focussing on the survey point

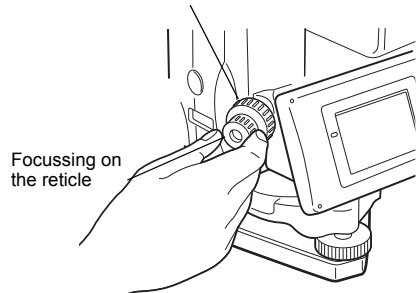

7.2 Levelling

PROCEDURE

1. Adjust the levelling foot screws to center the survey point in the optical plummet reticle.
2. Center the bubble in the circular level by either shortening the tripod leg closest to the offcenter direction of the bubble or by lengthening the tripod leg farthest from the offcenter direction of the bubble. Adjust one more tripod leg to center the bubble.

Turn the levelling foot screws while checking the circular level until the bubble is centered in the center circle.

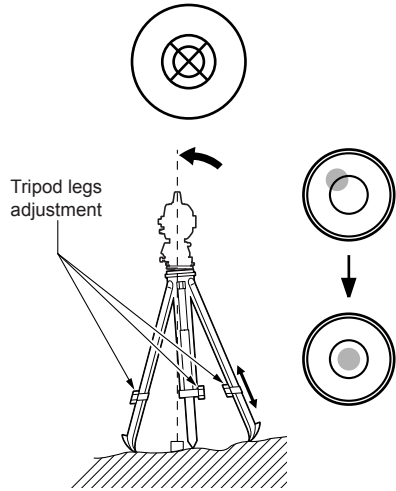

3. Power ON the instrument.
“●” indicates the bubble in circular level. The range of the inside circle is $\pm 1.5'$ and the range of the outside circle is $\pm 6'$.

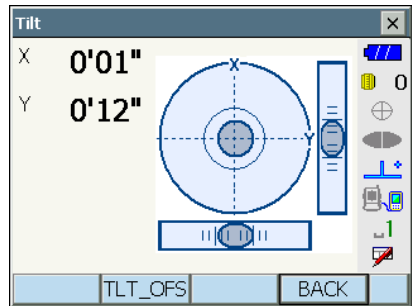

4. Center “●” in the circular level.
When the bubble is in the center, proceed to step 7.
5. Turn the instrument until the telescope is parallel to a line between levelling foot screws A and B.

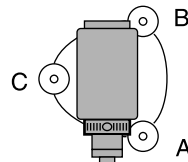

6. Set the tilt angle to 0° using foot screws A and B for the X direction and levelling screw C for the Y direction.

7. Loosen the centering screw slightly.
Looking through the optical plummet eyepiece, slide the instrument over the tripod head until the survey point is exactly centered in the reticle.
Retighten the centering screw securely.
8. Check again to make sure the bubble in the electric circular level is centered.
If not, repeat the procedure starting from step 6.
9. Press **{ESC}** to return to Observation mode.

8. POWER ON/OFF

PROCEDURE Power ON

1. Press the power key on the side of the instrument.
When the power is switched on, the Tilt screen is displayed.
Press **{ESC}** to go to top menu.

If "Out of range" is displayed, the instrument tilt sensor is indicating that the instrument is out of level. Level the instrument once again using circular level, then the tilt screen will be displayed.



- "Tilt crn." in "Obs. condition" should be set to "No" if the display is unsteady due to vibration or strong wind.
 "20.1 Observation Conditions"



Resume function

The Resume function redisplay the screen appearing before the instrument was powered OFF when the instrument is powered back ON. All parameter settings are also saved. Even if remaining battery power is completely depleted, this function will remain active for 1 minute, after which it is canceled. Replace a depleted battery as soon as possible.

PROCEDURE Power OFF

1. Press and hold (about 1sec) the power key on the side of the instrument.



- When there is almost no battery power remaining, the battery icon in the status bar will start to blink. In this event, stop measurement, switch off the power and charge the battery or replace with a fully charged battery.
- To save power, power to the instrument is automatically cut off if it is not operated for a fixed period of time. This time period can be set in "Power off" in <Inst.config.>.

 "20.2 Instrument Configuration"

8.1 Configuring the Touch Panel

When using for the first time, or after performing a cold boot, the screen for configuring the touch panel will be displayed.

Follow the instructions on the screen. Tap the crosshairs at the center of the display with the stylus pen. Tap 5 times. Press **{ENT}** to complete touch panel configuration. Press **{ESC}** to retain previous settings.



- Touch panel configuration can be performed at any time during normal operation by pressing **[PNL CAL]** in <Inst.config.>.
 - "20.2 Instrument Configuration"

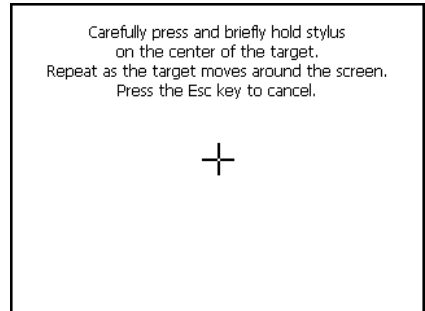

8.2 Resolving Software Issues

If you are experiencing problems with the instrument and suspect a fault in the program, you should try a warm boot. If the problem is not resolved with a warm boot the next step is to perform a cold boot. A warm boot will not erase surveying data in the instrument but will cancel the resume function. Whenever possible transmit the data to a personal computer before rebooting.

PROCEDURE

1. Power OFF the instrument.
2. Press the power key on the side of the instrument while pressing **{ENT}**.
The instrument is reset and powers ON as normal.



Cold boot

If the problem is not resolved with a warm boot the next step is to perform a cold boot. A cold boot will not erase surveying data in the instrument but all the parameters will be changed to the factory settings. If the data in the memory is necessary, **BE SURE TO TRANSFER IT TO A PERSONAL COMPUTER BEFORE PERFORMING A COLD BOOT.**

To perform a cold boot, while holding **{S.P.}**, and **{S.P.}**, press the power key on the side of the instrument.

The instrument is reset and powers ON as normal.

"20.11 Restoring Default Settings"



Problems Powering OFF

When the instrument cannot be powered OFF as normal, depress the reset button with the tip of the stylus pen.



- Pressing the Reset button may result in file and folder data being lost.

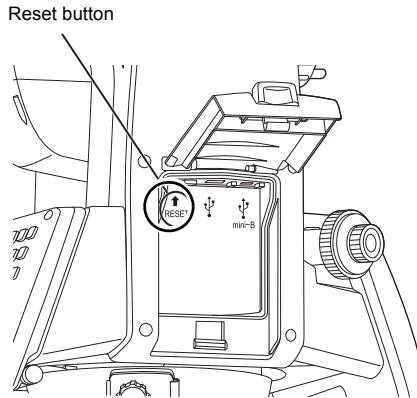

8.3 Powering ON/OFF from an External Instrument

The instrument can be powered ON/OFF from an external device such as a computer or data collector.



- The password must be input after powering ON the instrument from an external device when a password has been set.

 Remote PWR-On function: "20.2 Instrument Configuration", Setting a password: "20.9 Changing Password"

9. CONNECTING TO EXTERNAL DEVICES

The instrument supports *Bluetooth* wireless technology and RS232C for communication with data collectors etc. Inputting/outputting data is also possible by inserting a USB memory or by connecting to a USB device. Read this manual in conjunction with the operator's manual for the relevant external device.



- When doing *Bluetooth* communication, read "4.3 Bluetooth Wireless Technology".

9.1 Wireless Communication using *Bluetooth* Technology

The *Bluetooth* module incorporated in the instrument can be used for communication with Bluetooth devices such as data collectors.



Bluetooth connections

Communication between a pair of *Bluetooth* devices requires one device to be set as the "Master" and the other as the "Slave". To initiate connections from the PS side, set the PS as the "Master" device. To initiate connections from the paired device side, set the PS as the "Slave" device. The factory setting is "Slave".

PROCEDURE Necessary settings for *Bluetooth* communication



1. Select "Comms" in Config mode. Set Comms mode in the "Comms setup" tab to "*Bluetooth*".

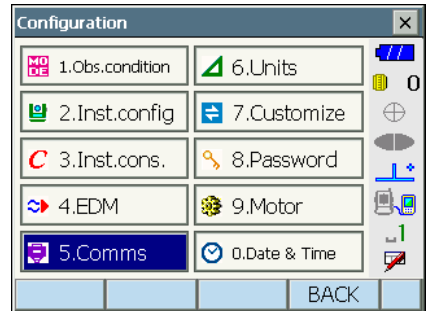

- Changing communication settings during *Bluetooth* communication will cancel the connection.
- The  status bar icon cannot be tapped in <Communication Setup>.



Items set and options (*: Factory setting)

- (1) Comms mode : RS232C*/*Bluetooth*
- (2) Check sum : yes/No*
- (3) Controller : Remote/2 Way/2 Way+Remote*
- (4) REC Type : REC-A (newly measured data is output)/REC-B (displayed data is output)*
- (5) Terminate  : ETX*/ETX+CR/ETX+CR+LF
- (6) TRK State : On (with track state information)/Off*
- (7) Ack mode  : On*/Off

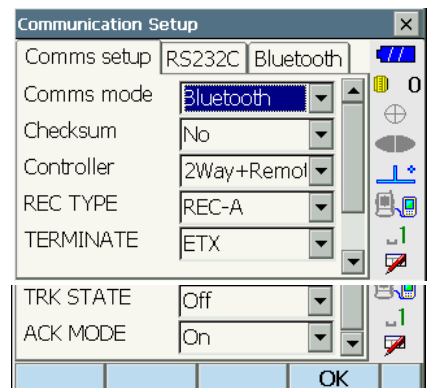



Terminate

Select the option Off or On for carriage return (CR) and line feed when collecting measurement data with a computer.



ACK mode

When communicating to an external device, the protocol for handshaking can omit the [ACK] coming from the external device so data is not sent again.

On : Standard

Off : Omit the [ACK]



- Setting (5) and (7) are for an instrument using GTS commands.

2. Select a mode for the PS in the "Bluetooth" tab. The factory setting is "Slave". Register companion devices.

- "Master" cannot be selected when no companion devices have been registered.
- ☞ "Master"/"Slave": "Bluetooth connections"

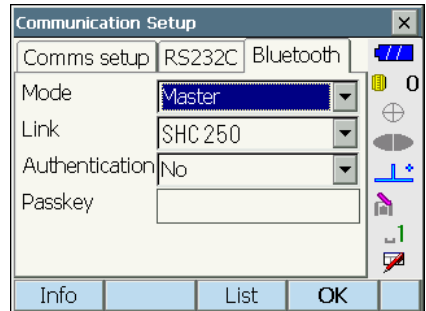

3. Select, in "Link", a companion device from among the Bluetooth devices already registered in the instrument.

☞ Registering devices: "PROCEDURE Registering Bluetooth companion devices"

- Companion devices cannot be selected when the PS is set as "Slave".

4. Set "Authentication" to "Yes" or "No". If "Authentication" is set to "Yes" for the PS the passkey will also need to be input on the companion device.

5. When "Authentication" is set to "Yes", input the same passkey as that for the intended companion device. Even if "Authentication" is set to "No", a passkey is requested when authentication is set on the companion device being used.
 - Up to 16 numeral characters can be input. Input characters will be displayed as asterisks (e.g. "*****"). The passkey was set to "0123" at the factory.
6. Press **[OK]** to finish settings.

PROCEDURE Registering Bluetooth companion devices

1. Power on the companion device.
2. Select "Bluetooth" in "Comms mode" in the "Comms setup" tab.
3. Press **[LIST]** to display a list of all registered devices.

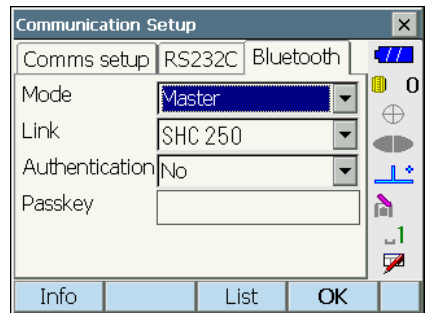

Register the data collectors to use in "Serial" tab and devices to use with the Dial-Up Program in "Dial-up" tab.



- Maximum number of devices registered: 6

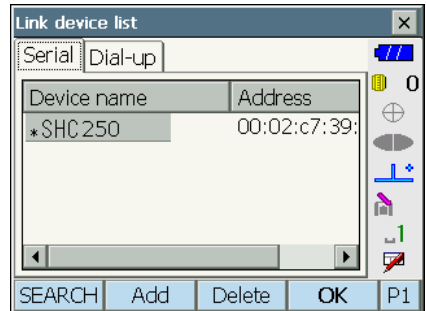

4. Register your Bluetooth device(s).

- Press **[Add]** to display <Add device>. Input the device name and *Bluetooth* address and press **[OK]**. Both should be 12 characters (numbers 0 to 9 and letters from A to F) in length.



- Press **[Search]** to search about *Bluetooth* devices in the immediate vicinity of the instrument and display their device name and address in a list. Select a device from this list and press **[OK]** to add to the Link device list in step 3.

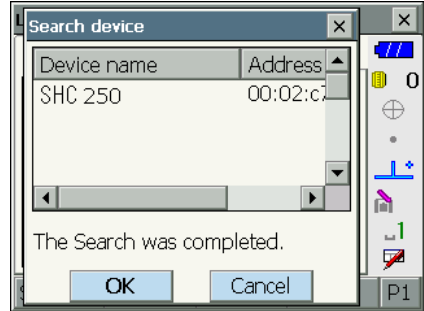

- Press **[Delete]** to delete the selected device name. Deleted device names cannot be retrieved.
- Select a device and press **[Edit]** in the second page to update the device name and/or device address.

5. Press **[OK]** to complete registration and return to the screen in step 2.

PROCEDURE Displaying *Bluetooth* information for the PS

1. Select "Comms" in Config mode.
2. Press **[Info]** in the "*Bluetooth*" tab to display information for the PS. Register the *Bluetooth* address (BD ADDR) displayed here in the paired device set as "Master".

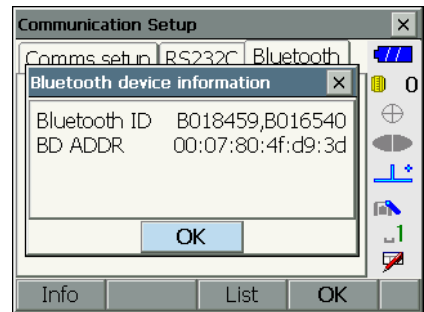

***Bluetooth* device address**

This is a number unique to one particular *Bluetooth* device used to identify devices during communication. This number consists of 12 characters (numbers 0 to 9 and letters from A to F). Some devices may be referred to by their *Bluetooth* device address.

9.2 Communication between the PS and Companion Device



- *Bluetooth* communication causes instrument battery power to be depleted at a rate higher than that for normal operation.
- Check that the companion device (data collector, computer, or cellular phone etc.) is turned on and the relevant *Bluetooth* settings are complete.
- All communication settings will be changed to factory settings when a cold boot is performed. Comms setup will need to be performed again.
 "9.1 Wireless Communication using Bluetooth Technology"

PROCEDURE *Bluetooth* communication

1. Complete the necessary PS settings for *Bluetooth* communication.

 "9.1 Wireless Communication using Bluetooth Technology"

2. Start communication

When PS is set as the "Master" device, the **[Connect]** softkey is allocated to the fourth page of Observation mode. When **[Connect]** is pressed the PS searches for the device selected in "Link" and a connection starts. When a connection has been successfully established  is displayed in the status bar.

The establishing of a connection can also be initiated by tapping  in the status bar.

 Status bar, communication status:"5.2 Display Functions"



- When PS is set as the "Slave" device, the establishing of a connection can only be initiated/canceled by the companion device set as "Master".
3. Press **[Cancel]** in the fourth page of Observation mode to terminate the connection. A connection can also be terminated by tapping  in the status bar.

9.3 Connection via RS232C cable

RS232C communication is possible, connecting instrument and a data collector with the cable.

PROCEDURE Basic cable settings

1. Power OFF the instrument and connect the instrument and a data collector with a interface cable.
 Cables: "25. OPPTIONAL ACCESSORIES"
2. Select "Comms" in Config mode.
 Set communication conditions in the "Comms setup" tab. Set "Comms mode" to "RS232C".
3. Set options in the "RS232C" tab according to the selection made in the "Comms setup" tab.

Items set and options (*: Factory setting)

- (1) Baud rate: 1200/2400/4800/9600*/19200/
38400bps
- (2) Data bits: 7/8* bits
- (3) Parity : Not set*/Odd/Even
- (4) Stop bit : 1*/ 2 bits

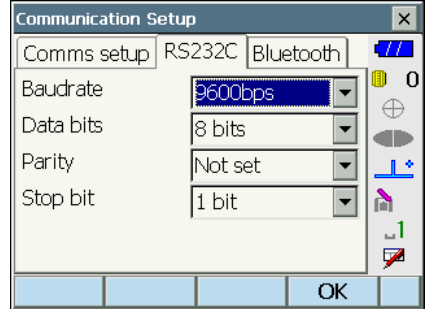
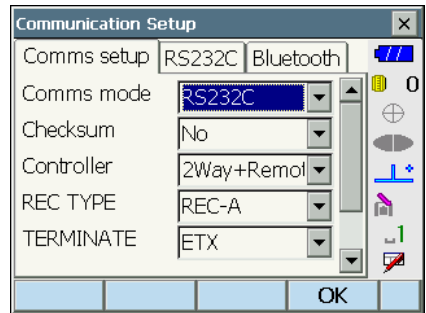

9.4 Connecting via USB Cable

Using USB port 2, the instrument and a computer can be communicated. There are USB mode and Mobile mode.



USB port

The instrument has two different USB ports. Each port is used for connection to different types of devices.

Port name	Device type
USB port 1	USB memory device.
USB port 2 (mini-B)	computers etc.

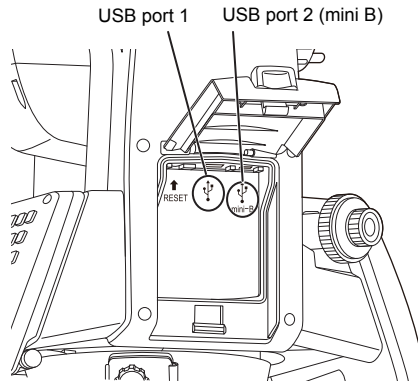

- TOPCON CORPORATION cannot guarantee that all USB devices are compatible with the PS USB ports.
- Use a computer WindowsXP/Vista/7 is based and USB connection is capable.
- Remove the USB cable from USB port 2 carefully to avoid damaging the cable.





- As for the download and install of "exFat file system driver"/ActiveSync/Windows Mobile Device Center, please access to Microsoft support site.

PROCEDURE Connecting the instrument to a computer to transfer data from instrument in USB mode

When connecting Windows XP, "exFat file system driver" needs to be installed to the computer.

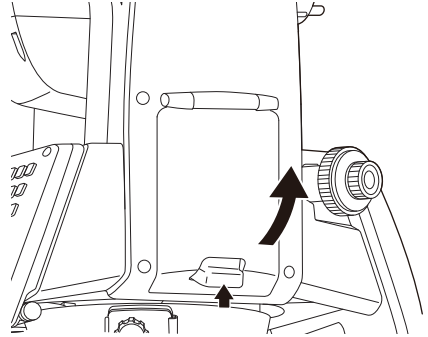
1. Slide up the catch on the external interface hatch to open.



2. Power OFF the instrument. Connect the USB port 2 on the instrument and computer using the USB cable.
 "8. POWER ON/OFF"

Note

- The computer does not need to be turned OFF before connection.

3. Press the power key on the side of the instrument while pressing **{ENT}** to display a message box asking whether to boot USB mode, then press **[YES]**.

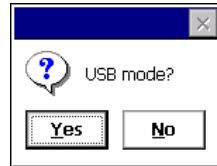

The screen of the instrument will be <USB Mode>.

Note

- instrument may not be displayed as <Removable Disk>. It depends on Windows settings.



Follow the instructions below to ensure that the instrument continues to operate normally during USB transfer.

- Do not change the folder hierarchy or folder names in <Removable Disk>.
- Do not format the "removable disk" on the computer.

4. Perform "Safely Remove Hardware"  in the task bar and disconnect the USB cable.

5. Press the power key and hold (about 1sec) to turn off the instrument to exit USB mode connection.

PROCEDURE Connecting the instrument to a computer to transfer data from instrument in Mobile mode

A synchronous software needs to be installed to the computer depending on the Windows version.

Computer to connect	Synchronous software
Windows XP	ActiveSync
Windows vista/7	Windows Mobile Device Center

1. Slide up the catch on the external interface hatch to open.
2. Power OFF the instrument. Connect the instrument and computer using the USB cable.
 "8. POWER ON/OFF"

Note

- The computer does not need to be turned OFF before connection.

3. Press the power key while pressing **{ENT}** to display a message box asking whether to boot USB mode, then press **[NO]**.
The synchronous software is effective.

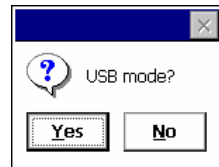

Note

- instrument may not be displayed as <Removable Disk>. It depends on Windows settings.



Follow the instructions below to ensure that the instrument continues to operate normally during USB transfer.

- Do not change the folder hierarchy or folder names in <Removable Disk>.
- Do not format the "removable disk" on the computer.

4. If synchronous software displays a partner setting screen on the computer and asks whether to set a partner device, press **[NO]**.



- A partner setting screen may not be displayed depending on the synchronous software settings.

5. Disconnect the USB cable to exit mobile mode connection.

9.5 Inserting USB Memory

Saving data in a USB memory or importing data from a memory is possible using the particular program on program mode.

USB ports: "9.4 Connecting via USB Cable"



- When reading/writing data, do not remove the USB memory.

PROCEDURE

1. Slide up the catch on the external interface hatch to open.

"9.4 Connecting via USB Cable"

2. Insert the USB memory into the USB port 1.



- When using a USB memory with 4 metal terminals on the surface, insert it with the terminal facing backwards to avoid damaging the USB port.

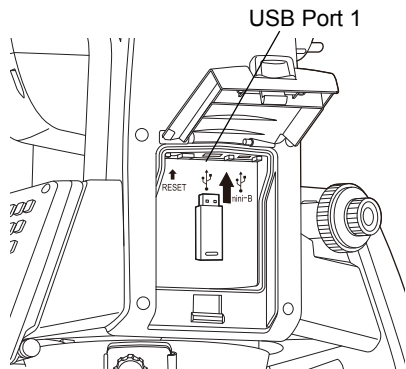

3. Close the external interface hatch until a click is heard.

4. Save data in the USB memory or import data from the memory.

Program Explanations of each program

10.TARGET SIGHTING

A target can be automatically sighted using the Auto Pointing function or manually sighted by the operator using the sighting collimator and telescope.

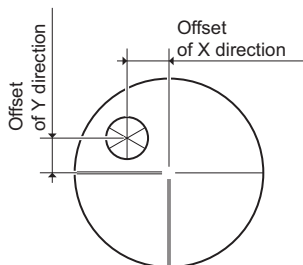

When Auto Pointing is performed, the image sensor on the instrument detects the light beam reflected from the target (prism or reflective sheet target), the offset between the target and telescope reticle is calculated by image processing, then the angle measurement value obtained from the encoder is compensated. There is a possibility that the target and telescope reticle are not aligned.



Caution

- The instrument emits a laser beam until the prism is sighted.



- Auto Pointing can only be performed when a prism or sheet is used as the target. For reflectorless measurement, the target must be sighted manually.
- Use designated reflective prisms/reflective sheets for higher precision measurement. Make sure reflector type and aperture/sheet size are set correctly in <EDM configurations>.
- Detach the handle if the prism is located at the zenith.
 "4.1 Parts of the Instrument Handle ► Detaching/attaching the Handle"
- Auto Pointing may take long time if the prism is located at the zenith. In this case, use optional accessory diagonal eyepiece (DE27) and manually sight the target.
 "10.3 Manually Sighting the Target"
- If more than one prism is located in the field of sight during Auto Pointing, an operation error will occur and the instrument will not be able to find the target.
- A prism beyond glass cannot be searched because a measurement error occurs.
- If an obstacle blocks the laser beam path between the instrument and the prism, instrument cannot find the target correctly.
- If strong light shines directly into the objective lens, measurement cannot be performed correctly.
- Position the prism in alignment with the objective lens. A prism with a prism constant correction value of -40mm can eliminate the error caused by tilted prism.
 "27.1 High Accuracy with the 360° Prism"
- The following table suggests what size target to use for different distances when performing Auto Pointing with a reflective sheet target.

Distance	Target size
5 to 15m	RS10 (10mm)
5 to 30m	RS30 (30mm)
5 to 40m	RS50 (50mm)
10 to 50m	RS90 (90mm)

10.1 Auto Pointing Settings

PROCEDURE

1. Select "Motor" in <Configuration>.
 - Set Auto Pointing functions in the Configuration tab.
 - Set "Track Setting" to "Search".

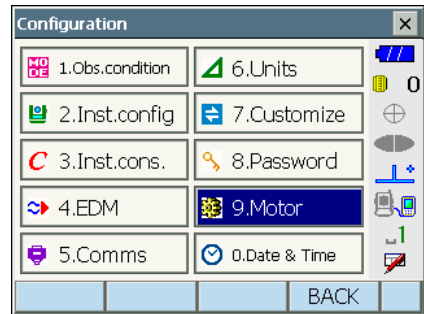

Items set and options (*: Factory setting)

- (1) AUTO AIM : Fine/Rapid*
- (2) MEAS Acc. : Advanced/Standard*
- (3) Track Setting
 - Auto Pointing model: None/Search*
 - Auto Tracking model: None/Search/Track*
- (4) Srch method : G.S.*/R.C.
- (5) TURN : 3"/5"/10"/20"/30"/60"

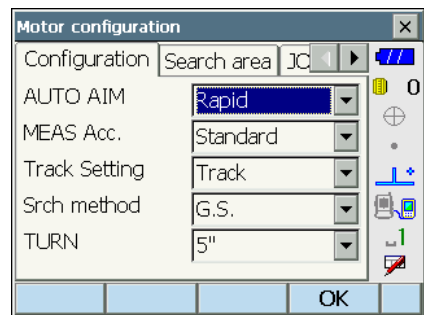

AUTO AIM

When the target enters the field-of-view within the set limit for Auto Pointing completion (the limit differs between "Fine" and "Rapid"), the instrument starts acquiring data (the amount of data differs between "Fine" and "Rapid") then completes the Auto Pointing by calculating the data. Set to "Fine" for greater accuracy during Auto Pointing. Make sure that the prism is securely mounted on a tripod etc.

Set to "Rapid" when supporting the pole by hand.

When "Fine" is set the instrument checks that the prism position is stable, then searches for the prism direction. Once the instrument confirms that the prism is sighted at the approximate center of the field-of-view, Auto Pointing is complete. Although this setting provides greater accuracy, when supporting the pole by hand, hand movements will result in Auto Pointing taking too long to complete and a "Time out" error will occur.

When "Rapid" is set however, Auto Pointing can be performed even with slight instability of prism position or minor shifts of target position in the field-of-view. The instrument will use the data obtained to determine the direction of the target.

Auto Pointing performed using the "Rapid" setting can be completed in a much quicker time than the "Fine" setting.

"Fine" is recommended when a high level of measurement accuracy is needed. The range for the offset between the target and reticle after Auto Pointing completed changes as shown below depending on the Srch. accuracy setting.

**Measure Acc.**

This setting refers to internal operation of the Auto Pointing function.

In the "Advanced" setting, Auto Pointing movement before completion is constant. As a result, Auto Pointing takes longer to complete depending on the target position, but sighting accuracy is improved.

In the "Standard" setting, Auto Pointing movement is not constant, because the most direct way to the target is chosen. That means the "Standard" setting enables Auto Pointing at a comparatively faster speed than "Advanced".

In the "Advanced" setting, the offset between telescope reticle and the target center may larger than that of "Standard".

**Srch method**

Selects search before distance measurement option.

When set to "G.S." the instrument will search for the target in the area specified in the Search area tab. When set to "R.C.", the instrument will wait for a Turning command to be issued from the RC-Controller before starting Auto Pointing. Such commands can only be received when using instruments have a .

**TURN**

This option allows the user to set a tolerance range for setting accuracy (after rotation to a specified angle). For example, when this option is set to 30" and **[INV]**, **[H.ANG]**, or **[ROTATE]** is pressed, the instrument will stop rotation within 30" of the specified rotation angle.

**Search operation during Auto Pointing**

When the target enters the field-of-view within the set limit (setting of "Auto AIM" and "Measure Acc.") for Auto Pointing completion, the instrument stops moving, calculates the offset between the target and telescope reticle by image processing, then compensates the angle measurement value obtained from the encoder. This compensation enables accurate sighting in a short time. Even though the target and telescope reticle may appear to be misaligned, actual angle value of center of the target is displayed. Compensated values are displayed in blue.

If the instrument is rotated (manually or using the Jogs) more than 10", compensation will be canceled, the angle reverts to that obtained from the encoder, and the angle values are once again displayed in black. Compensation is automatically performed when performing Auto Tracking. Terminating Auto Tracking or powering OFF the instrument will cancel the compensation function.

- Set the area in which to perform target sighting in the Search area tab.

Angle values can only be specified in 1° steps.
Input values not conforming to this format will be automatically rounded up.

Items set and options (*: Factory setting)

- Search pattern :

PS-101A/102A/103A/105A	: 1*/2/3
PS-101AC/102AC/103AC/105AC	: 3 (fixed)
- Vertical : 0 to 90° (15*)
- Horizontal : 0 to 180° (15*)
0 to 90° (15*) (when
"Search pattern" is set
to "3")

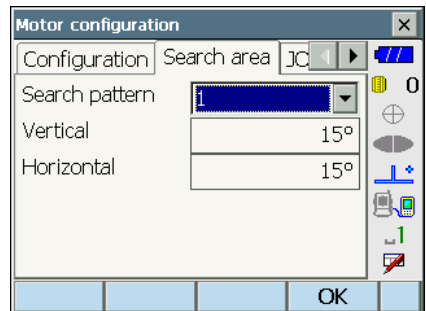



Search pattern

The search pattern is the rotating method of telescope and instrument to find the target prism in search mode.

In Pattern "1" instrument starts searching the prism at the point where the prism is lost and gradually expands the searching area in vertical direction, keeping the horizontal angular width.

Pattern "2" can be selected to search for the prism. The search pattern tries to locate the prism in a very short time.

In pattern "3", instrument starts searching the prism at the point where the prism is lost and gradually expands the searching area in horizontal and vertical direction.

In every pattern, the searching is arranged to 2 times until the reflector is found. The auto tracking mode changes to manual mode when the reflector could not found out within 2 times searching, and returns to the point where the reflector is lost.



Pattern "1"



Pattern "2"



Pattern "3"

•: Start point for search

- Set the Jog turning speed for vertical and horizontal rotation of the telescope. The "Shift" point signifies the Jog turning speed at which telescope rotation switches from the Lo speed setting to the Hi speed setting. The higher the "Shift" point setting, the faster the Jog turning speed needed to activate the Hi speed setting.

Items set and options (*: Factory setting)

- Lo : 1 to 4 (3*) (steps. 4 is fastest)
- Hi : 1 to 7 (4*) (steps. 7 is fastest)
- Shift : 1 to 6 (2*) (steps)

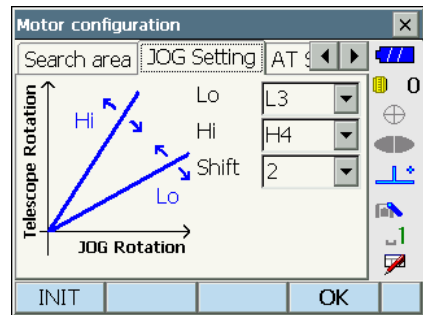

Press **[INIT]** to return JOG Setting tab settings only to their factory settings.

- Press **[OK]**.

10.2 Auto-Pointing Function for Target Sighting

PROCEDURE

- Use the sighting collimator to aim the objective lens in the general direction of the target. The vertical and horizontal Jogs can be used for precise adjustments of the instrument and telescope
 - JOG Setting tab: "10.1 Auto Pointing Settings" step 3.

- Press **[SRCH]** in any Observation mode screen. The telescope and top half of the instrument rotate and target auto-search begins. When the target is found, the instrument sights the prism and stops.

 Allocating the **[SRCH]** softkey:
"20.6 Allocating Key Functions"

Note

- When "Search" is selected in "Track Setting" in the "Configuration" tab of <Motor configuration>, the function of the following softkeys will change depending on the option selected in "Srch. method".
 Motor settings: "10.1 Auto Pointing Settings"
- "Turning" operation: The instrument locates the Remote Controller by detecting the laser beam output by the Remote Controller, then starts Auto Pointing.

"Motor" setting Softkey	When "Search" set in "Track Setting"		When "None" set in "Track Setting"
	"Srch method" is R.C.	"Srch method" is G.S. (Global Search)	
[SRCH]	Performs Auto Pointing		
[MEAS]	Performs Turning operation then angle/distance measurement	Performs Auto Pointing then angle/distance measurement	Performs angle and distance measurement
[RC]	Rotates directly in the direction of the RC-Controller then performs Auto Pointing		
[<-RC]	Rotates in a counterclockwise direction (from the point of view of the RC-Controller) then performs Auto Pointing		
[RC->]	Rotates in a clockwise direction (from the point of view of the RC-Controller) then performs Auto Pointing		
[RC Cont]	Nullifies the current measurement position then continues Turning operation		
[AT On] (Auto Tracking model only)	Performs Turning operation then Auto Tracking	Performs Auto Pointing then Auto Tracking	Performs Auto Tracking *1

*1: Pressing **[AT On]** when "Track Setting" is set to "None" will result in one of the following operations

being performed.

When "R.C." selected: Performs Turning operation then Auto Tracking

When "G.S." selected: Performs Auto Pointing then Auto Tracking

10.3 Manually Sighting the Target



- When sighting the target, strong light shining directly into the objective lens may cause the instrument to malfunction. Protect the objective lens from direct light by attaching the lens hood. Observe to the same point of the reticle when the telescope face is changed.

PROCEDURE

- Focus on the reticle**
Look through the telescope eyepiece at a bright and featureless background.
Turn the eyepiece screw clockwise, then counterclockwise little by little until just before the reticle image becomes focussed.
Using these procedures, frequent reticle refocussing is not necessary since your eye is focussed at infinity.
- Sight the target**
Use the Sighting collimator to bring the target into the field of view. Turn the vertical and horizontal Jogs for fine sighting adjusting.
- Focus on the target**
Turn the telescope focussing ring to focus on the target.
Turn the vertical and horizontal fine motion screws to align the target with the reticle.
The last adjustment of each fine motion screw should be in the clockwise direction.
- Readjust the focus until there is no parallax**
Readjust the focus with the focussing ring until there is no parallax between the target image and the reticle.

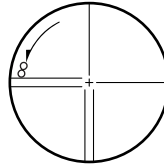

Eliminating parallax

This is the relative displacement of the target image with respect to the reticle when the observer's head is moved slightly before the eyepiece. Parallax will introduce reading errors and must be removed before observations are taken. Parallax can be removed by refocussing the reticle.



Sighting manually

When sighting manually, set "Track Setting" to "None" in <Motor Configuration> Configuration tab, then use the Sighting collimator to bring the target into the field of view. When the target is in the field-of-view, use the Jogs to make fine adjustments and accurately sight the center of the prism.

It is recommended that a slow Jog turning speed is used for greater stability when performing fine adjustments.

11.MEASUREMENT WITH AUTO TRACKING

With the Auto Tracking function, the instrument searches for and sights the target. The instrument will then following that target as it is moved from measurement point to measurement point. The Remote Control System is recommended for high performance Auto Tracking measurement.

Caution

- The instrument emits a laser beam during Auto Pointing and Auto Tracking operation.



- Auto Pointing model does not support Auto Tracking.
- Auto Tracking can only be performed when a prism is used as the target. Auto Tracking is not possible with reflective sheet and reflectorless measurement.
- Use designated reflective prisms for higher precision measurement.
  "24. PRISM System"
- If more than one prism is located in the field of sight during Auto Tracking, an operation error will occur and the instrument will not be able to find the target.
- The instrument cannot perform Auto Pointing/Auto Tracking when there is glass between the instrument and the prism. A measurement error will occur.
- If an obstacle blocks the laser beam path between the instrument and the prism, instrument cannot find the target correctly.

11.1 Auto Tracking Settings

PROCEDURE

1. Select "Motor" in <Configuration>.
 Select the Configuration tab.
 Set "Track Setting" to "Track".

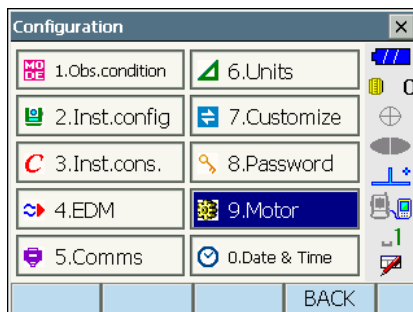

Configuration tab: "10.1 Auto Pointing Settings"

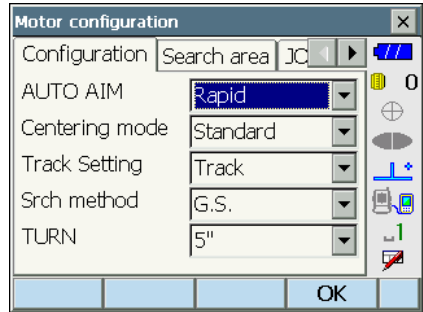

- Set the area in which to perform target sighting in the Search area tab.

Search area tab: "10.1 Auto Pointing Settings" Step 2

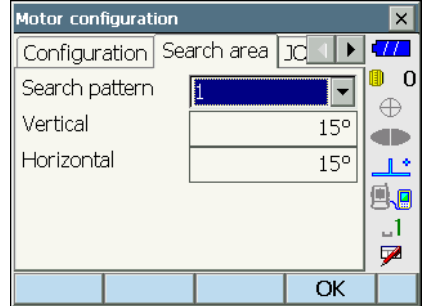

- When necessary, set the Jog turning speed for vertical and horizontal rotation of the telescope.

JOG Setting tab: "10.1 Auto Pointing Settings" step 4

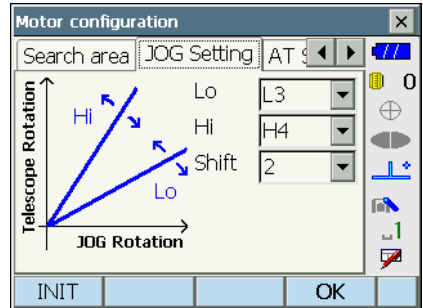

Press [INIT] to return JOG Setting tab settings only to their factory settings.

- Set "Forecast time" and "Target lost".

"Forecast time", "Target lost": Lost Prism

Items set and options (*: Factory setting)

(1) Forecast time : 0.5 sec./1 sec./2 sec.*/
3 sec./4 sec./5 sec./
Auto

(2) Wait time (sec.) : 0 to 3600 (5*)

- When setting "Wait time", [HOLD] is displayed. Press [HOLD] to set "Wait time" to no limits.

"Lost Prism"

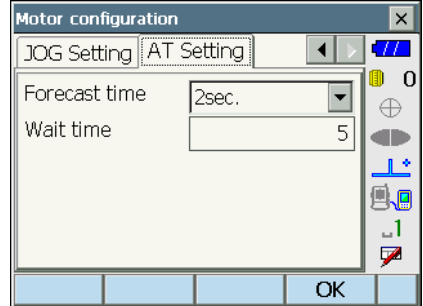

- Press [OK].

11.2 Stating up External Link and Settings

Start up External Link in the program selection screen to perform observation with auto tracking, communicating with a particular data collector. Do the communication setup here.

PROCEDURE

1. Select "External Link" in the program mode screen.
External Link starts up.

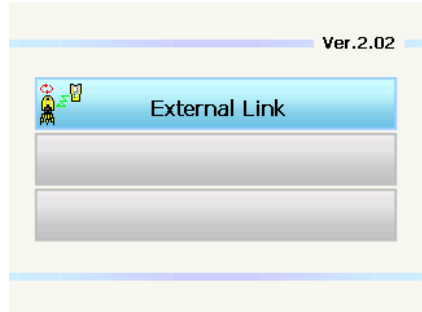

2. Press **[Setting]** in <EXTERNAL LINK>.
 - If settings are not necessary, press **[END]**.

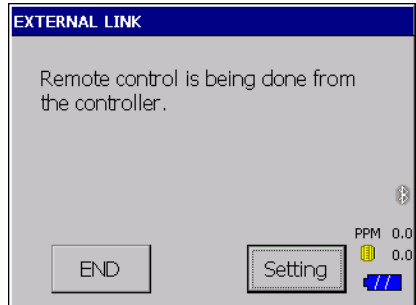

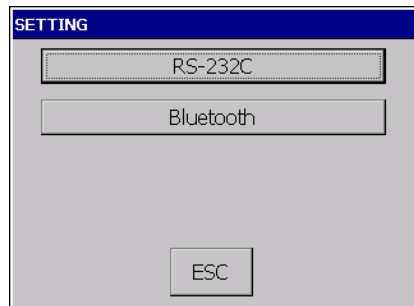

3. Press **[Bluetooth]** in <SETTING>.



4. Set communication conditions for the data collector used.

Items set and options (*: Factory setting)

- (1) *Bluetooth* : Enable*/Disable
 (2) REC Type : REC-A (newly measured data is output)/REC-B (displayed data is output)*
 (3) Terminate  : ETX*/ETX+CR/ETX+CR+LF
 "9.1 Wireless Communication using Bluetooth Technology  Terminate"

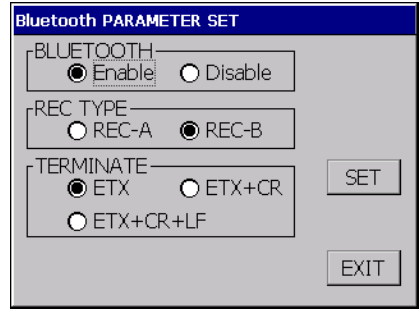

5. Press **[SET]** to finish settings and return to the screen in step 2.



- Items set and options of pressing **[RS-232C]** in step 3 are as follows.

Baud rate	: 1200/2400/4800/9600*/19200/38400/57600/115200bps
Data bits	: 7/8* bits
Parity	: Not set*/Odd/Even
Stop bit	: 1*/ 2 bits
REC Type	: REC-A (newly measured data is output)/REC-B (displayed data is output)*
Terminate	: ETX*/ETX+CR/ETX+CR+LF
RTS	: Low/High*

11.3 Measurement with Auto Tracking

PROCEDURE

- Use the sighting collimator to aim the objective lens in the general direction of the target. (The vertical and horizontal Jogs can be used for precise adjustments of the instrument and telescope.)
 JOG Setting tab: "10.1 Auto Pointing Settings" step 4
- Select **[MEAS]**, **[RC Cont]**, or **[SRCH]** in any Observation mode screen. The telescope and top half of the instrument rotate and target auto-search begins. When the target is found, the target is aligned in the field-of-view and Auto Tracking starts.

3. Press **[AT Off]** in a Observation mode screen to stop Auto Tracking.

- When **[STOP]** is pressed, distance measurement will stop but Auto Tracking will remain active.



Lost Prism

In the event that an obstacle prevents the instrument sighting the target during Auto Tracking, the instrument will predict the direction in which the target will travel and continue Auto Tracking based on this prediction for the time period set in "Forecast time". If the instrument re-acquires the target in this predicted direction, Auto Tracking continues without change. If the target is not re-acquired however, the target is considered "lost" ("Target lost" status) and the instrument starts "horizontal search", "Prism wait" and "re-search" in order. If the instrument re-acquires the target in this process , Auto Tracking continues.

"Prism wait" will continue for the time period set in "Wait time".

If the target is not re-acquired after "re-search", sighting terminates. Start Auto Tracking procedure again from step 1.

"Wait time" being set to "HOLD" (no limits), Auto Tracking procedure is as follows. The telescope does not move and keeps "Prism wait" status and when the prism comes into the field of view, the instrument starts Auto Tracking.

"Forecast time" (duration of search in predicted direction) and "Wait time" settings: "10.1 Auto Pointing Settings" step 4

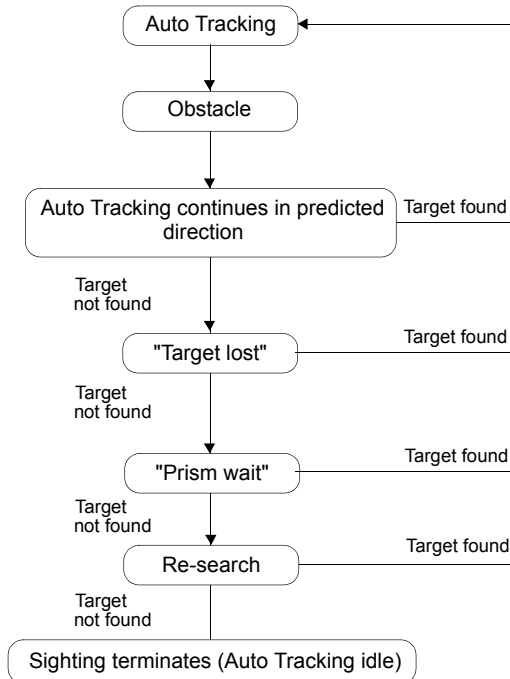

Note

- When "Tracking" is selected in "Trach Setting" in the "Configuration" tab of <Motor configuration>, the function of the following softkeys will change depending on the option selected in "Srch method" and Auto Tracking will be added.

 Motor settings: "10.1 Auto Pointing Settings", "Forecast time" and "Target lost" operation: "11.1 Auto Tracking Settings"

"Motor" setting Softkey	When "Track" set in "Track Setting"		When "None" set in "Track Setting"
	"Srch method" is R.C.	"Srch method" is G.S. (Global Search)	
[SRCH]	Performs Auto Pointing then Auto Tracking		Performs Auto Pointing
[MEAS]	Performs Turning operation then distance measurement/Auto Tracking	Performs Auto Pointing then distance measurement/Auto Tracking	Performs angle and distance measurement
[RC]	Rotates directly in the direction of the RC-Controller then performs Auto Pointing		Rotates in the direction specified by the RC-Controller then performs Auto Pointing
[<-RC]	Rotates in a counterclockwise direction (from the point of view of the RC-Controller) then performs Auto Pointing/Auto Tracking		Rotates in a counterclockwise direction (from the point of view of the RC-Controller) then performs Auto Pointing
[RC->]	Rotates in a clockwise direction (from the point of view of the RC-Controller) then performs Auto Pointing/Auto Tracking		Rotates in a clockwise direction (from the point of view of the RC-Controller) then performs Auto Pointing
[RC Cont]	Nullifies the current measurement position then continues Turning operation/Auto Tracking		Nullifies the current measurement position then continues Turning operation
[AT On]	Performs Turning operation then Auto Tracking	Performs Auto Pointing then Auto Tracking	Performs Auto Tracking *1

*1: Pressing [AT On] when "Track Setting" is set to "None" will result in one of the following operations being performed.
 When "R.C." selected: Performs Turning operation then Auto Tracking
 When "G.S." selected: Performs Auto Pointing then Auto Tracking



Turning operation

The instrument locates the Remote Controller by detecting the laser beam output by the Remote Controller, then starts Auto Pointing.

12. ANGLE MEASUREMENT

This section explains the procedures for basic angle measurement in Observation mode.

- It is possible to allocate softkeys in measurement menus to suit various applications and the ways that different operators handle the instrument.

☞ "20.6 Allocating Key Functions"

12.1 Measuring the Horizontal Angle between Two Points (Horizontal Angle 0°)

Use the "OSET" function to measure the included angle between two points. The horizontal angle can be set to 0 at any direction.

PROCEDURE

1. Sight the first target as at right.

☞ "10. TARGET SIGHTING"

2. In the first page of Observation mode, press

[OSET].

[OSET] will flash, so press **[OSET]** again.

The horizontal angle at the first target becomes 0°.

3. Sight the second target.

The displayed horizontal angle (HA-R) is the included angle between two points.

1st target

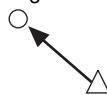

Instrument Station

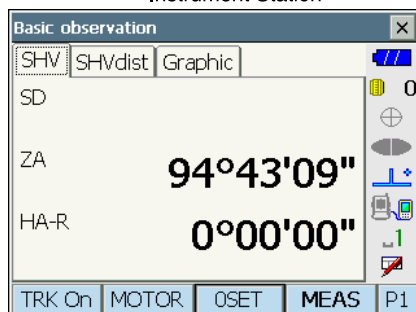

2nd Target

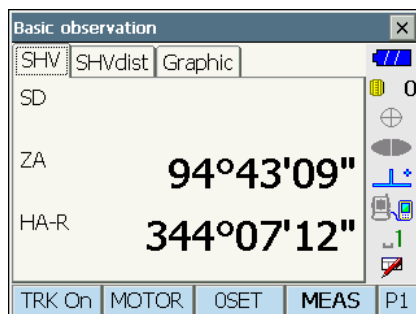

12.2 Setting the Horizontal Angle to a Required Value (Horizontal Angle Hold)

You can reset the horizontal angle to a required value and use this value to find the horizontal angle of a new target.

PROCEDURE

1. Sight the first target.
2. In the second page of Observation mode, press **[H-SET]**. <Set H angle> is displayed.
3. Enter the angle you wish to set, then press **[OK]**. The value that is input as the horizontal angle is displayed.

- The same setting can also be performed with coordinate and azimuth input.

 "14.2 Azimuth Angle Setting"

4. Press **[OK]** to confirm the input value and display the new horizontal angle.

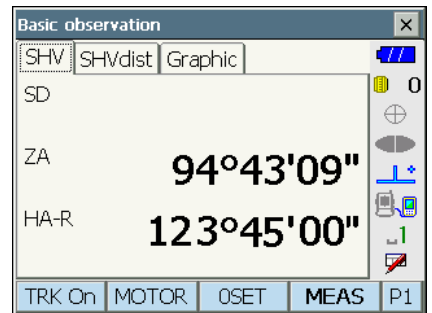
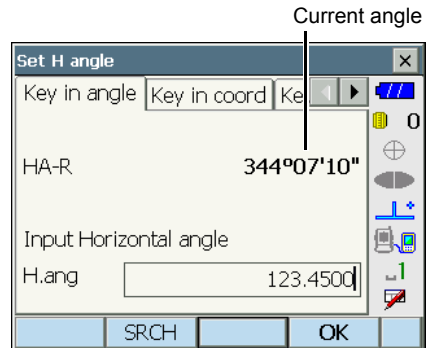

5. Sight the second target. The horizontal angle from the second target to the value set as the horizontal angle is displayed.

Note

- Pressing **[HOLD]** performs the same function as above.
- Press **[HOLD]** to set the displayed horizontal angle. Then, set the angle that is in hold status to the direction you require.

 Allocating **[HOLD]**: "20.6 Allocating Key Functions"

12.3 Turning the Instrument from the Reference Angle to a Specified Angle

The instrument automatically turns from the reference direction to the specified angle (target).

- instrument also turns to the target coordinates when reference angle is omitted.



- Rotation may not be completed correctly when specifying an angle near the zenith or nadir if "Tilt crn." or "Coll. crn" is set to "Yes" in "Obs.condition".

PROCEDURE

1. Sight the point you will use as the reference angle and set it as the reference angle.

Sight the reference point and press **[OSET]**, or input the reference point angle.

- ☞ "12.1 Measuring the Horizontal Angle between Two Points (Horizontal Angle 0°)/"12.2 Setting the Horizontal Angle to a Required Value (Horizontal Angle Hold)"

2. Press **[MOTOR]** in the first page of Observation mode and enter the vertical and horizontal angles in the Motor tab.

- Desired angle can be calculated by inputting the coordinates of station point and target point. Press **[COORD]** in the second page and set station point. Press **[OK]** to calculate the angle.

指定角回転	
鉛直角	90.0000
水平角	0°00'00"
鉛直角	86°14'20"
水平角	332°28'00"

サーチ 振り向 追尾開始 旋回 P1

3. After confirming the angle, press **[ROTATE]**. The instrument moves to the point (target) entered in step 2.

- The following operation can be select in the second page.

[COORD] : set the angle by coordinates

[INV]: : rotate the top of the instrument and telescope 180°

[CNFG]: : set motor settings

☞ "11.1 Auto Tracking Settings"



Fixed velocity rotation

The instrument horizontal angle and telescope can be rotated using the controls in the Fixed velocity rotation tab. Speed settings are from 1 to 16. Allocate **[Fix Vel]** in Observation mode to use this function.

Tap the touch panel in the desired rotation direction.

Tap the red center circle/  in the status bar or to press **{ESC}** to stop rotation.

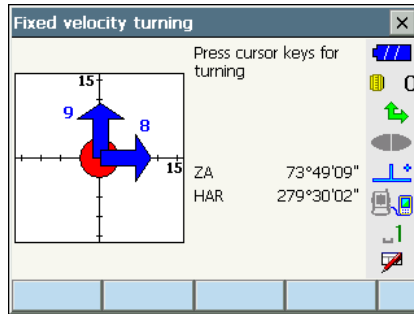

12.4 Angle measurement and Outputting the Data

The following explains angle measurement and the features used to output measurement results to a computer or other external devices.

 "9. CONNECTING TO EXTERNAL DEVICES", Cables: "25. OPPTIONAL ACCESSORIES",
Output format and command operations: "Communication manual"

PROCEDURE

1. Connect instrument and external device.
2. Allocate the **[HVOUT-T]** or **[HVOUT-S]** softkey to the OBS mode screen.
 "20.6 Allocating Key Functions"

Note

- Pressing the softkey outputs data in the following format.

[HVOUT-T] : GTS format

[HVOUT-S] : SET format

3. Sight the target point.
4. Press **[HVOUT-T]** or **[HVOUT-S]**.
Output measurement data to peripheral equipment.

13.DISTANCE MEASUREMENT

Perform the following settings as preparation for distance measurement in Observation mode.

- Distance measurement mode
- Target type
- Prism constant correction value
- ppm
- Search area
- Auto Pointing/Auto Tracking
 - ☞ "10.1 Auto Pointing Settings", "11.1 Auto Tracking Settings", "20.3 EDM Settings"
- It is possible to allocate softkeys in measurement menus to suit various applications and the ways that different operators handle the instrument.
 - ☞ "20.6 Allocating Key Functions"

Caution

- When using the laser-pointer function, be sure to turn OFF the output laser after distance measurement is completed. Even if distance measurement is canceled, the laser-pointer function is still operating and the laser beam continues to be emitted.



- Make sure that the target setting on the instrument matches the type of target used. The instrument automatically adjusts the intensity of the laser beam and switches the distance measurement display range to match the type of target used. If the target does not correspond to the target settings, accurate measurement results cannot be obtained.
- Accurate measurement results cannot be obtained if the objective lens is dirty. Dust it off with the lens brush first, to remove minute particles. Then, after providing a little condensation by breathing on the lens, wipe it off with the wiping cloth.
- During reflectorless measurement, if an object obstructs the light beam used for measurement or an object is positioned with a high reflective factor (metal or white surface) behind the target, accurate measurement results may not be received.
- Scintillation may affect the accuracy of distance measurement results. Should this occur, repeat measurement several times and use the averaged value of the obtained results.

13.1 Returned Signal Checking

Check to make sure that sufficient reflected light is returned by the target sighted by the telescope. Checking the returned signal is particularly useful when performing long distance measurements.

Caution

- The laser beam is emitted during returned signal checking.



- When the light intensity is sufficient even though the center of the reflective prism and the reticle are slightly misaligned (short distance etc.), "●" will be displayed in some cases, but in fact, accurate measurement is impossible. Therefore make sure that the target center is sighted correctly.

PROCEDURE

1. Accurately sight the target.
2. Press **[S-LEV]** in observation mode.
<Aiming> is displayed.
☞ Allocating **[S-LEV]**: "20.6 Allocating Key Functions"

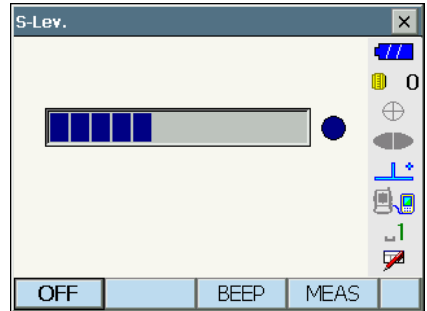

When **[S-LEV]** is pressed, a gauge indicating light intensity is displayed.

- The more [■■■■] displayed, the greater the quantity of reflected light.
- If "●" is displayed, only enough light for the measurement is returned.
- When "●" is not displayed, accurately resight the target.

[BEEP]/[OFF] : Sets a buzzer sound when measurement is possible. Press to switch on and off.

[MEAS] : Returns to Observation mode and starts angle and distance measurement regardless of "Track Setting" setting.

3. Press **[OFF]** to finish signal checking.
Press **{ESC}** or tap the cross in the top-right corner to return to the previous screen.

Note

- When [■■■■] is displayed persistently, but "●" is not, contact your local dealer.
- If no key operations are performed for two minutes, the display automatically returns to the previous screen.

13.2 Using the Guide Light in Distance Measurement

The color and flashing speed of the guide light indicates the status of the instrument and can be known when the user is located at a distance from the instrument.

 Switching the guide light ON/OFF "5.1 Basic Key Operation"

- The pattern of the guide light can be changed.

 "20.2 Instrument Configuration"



- Even if the guide light is set to ON, the guide light is OFF during distance measurement with the target type "N-Prism" or returned signal checking.

● Guide light status and meaning

Status of the instrument

Light status	Meaning
Slow flashing (Red and green simultaneously)	Waiting
	Search error (error screen only)
Fast flashing (Red and green simultaneously)	Searching in progress
	Measuring (continuous measurement)
	Returned signal checking in progress
	Auto Tracking in progress (Auto Tracking model only)
	Auto Tracking in predicted direction (Auto Tracking model only)
Green and red alternate flashing	Distance measurement error (no signal, sighting error)
	"Prism wait"

● Guide light status and meaning (while using "External Link")

Status of the instrument

Light status	Meaning
Slow flashing (Red and green simultaneously)	Waiting
Fast flashing (Red and green simultaneously)	Auto Tracking in progress (Auto Tracking model only)
	Auto Tracking in predicted direction (Auto Tracking model only)
Green and red alternate flashing	Searching in progress
	"Prism wait"

13.3 Distance and Angle Measurement

An angle can be measured at the same time as distance.

- The search range can be set.
 "10.1 Auto Pointing Settings"

Caution

- The laser beam is emitted during Auto Pointing and Auto Tracking.

PROCEDURE

- Face the instrument in the direction of the target
Use the sighting collimator to aim the instrument and telescope toward the target.
 "10. TARGET SIGHTING"
- Start measurement.
Press **[MEAS]** in the first page of Observation mode to start measurement.

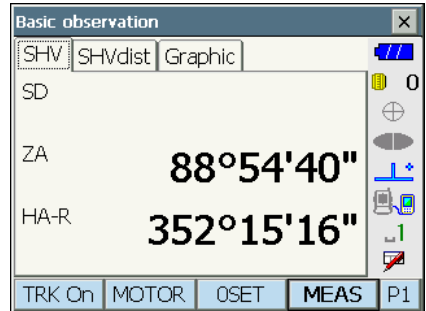

The measured distance data (SD), vertical angle (ZA), and horizontal angle (HA-R) are displayed.

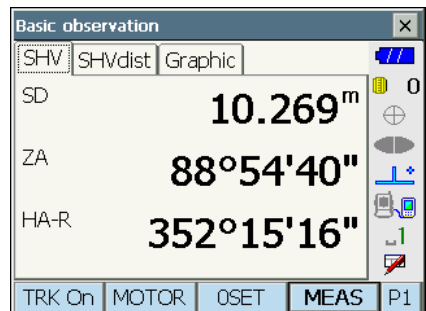

- Press **[STOP]** to quit distance measurement.

Note

- If the single measurement mode is selected, measurement automatically stops after a single measurement.

- During fine average measurement, the distance data is displayed as SD1, SD2,... to SD9. When the designated number of measurements has been completed, the average value of the distance is displayed in the "SDA" line.
- If the tracking measurement is conducted with the target type "N-Prism", the measured data for a distance exceeding 250m is not displayed.
- The distance and angle that are most recently measured remain stored in the memory until the power is off and can be displayed at any time by pressing **[CALL]**.
☞ Allocating **[CALL]**: "20.6 Allocating Key Functions"

13.4 Distance Measurement and Outputting the Data

The following explains distance measurement and the features used to output measurement data to a computer or external devices.

☞ "9. CONNECTING TO EXTERNAL DEVICES", Communication cables: "25. OPPTIONAL ACCESSORIES". Output format and command operations: "Communication manual"

PROCEDURE

1. Connect instrument and external device.
2. Sight the target point.
3. Press **[HVDOUT-T]** or **[HVDOUT-S]** to measure the distance and output the data to the external device.
4. Press **[STOP]** to stop outputting data and return to Obs Mode.

13.5 REM Measurement

An REM measurement is a function used to measure the height to a point where a target cannot be directly installed such as power lines, overhead cables and bridges, etc.

The height of the target is calculated using the following formula.

$$Ht = h_1 + h_2$$

$$h_2 = S \sin \theta_{z1} \times \cot \theta_{z2} - S \cos \theta_{z1}$$

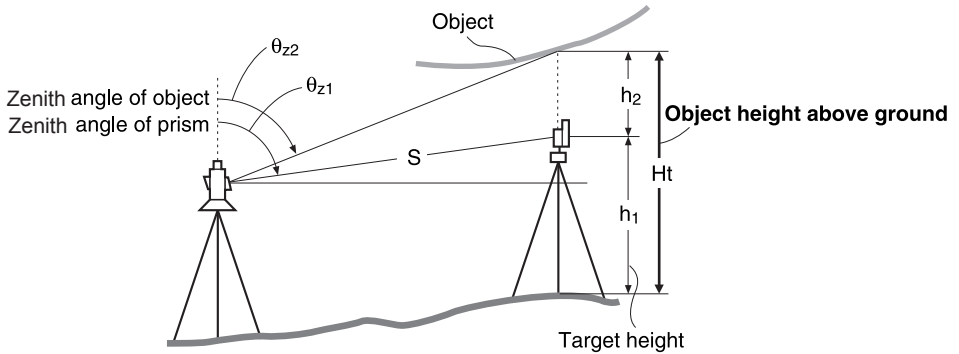

- It is possible to allocate softkeys in measurement menus to suit various applications and the ways that different operators handle the instrument.
 ☞ "20.6 Allocating Key Functions"

PROCEDURE

- Set the target directly under or directly over the object and measure the target height with a tape measure etc.

Press [HT] and enter the target height.

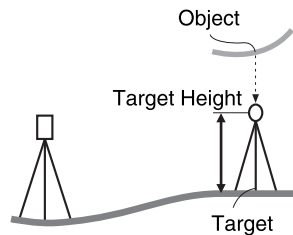

- Select "REM" in <Menu>.

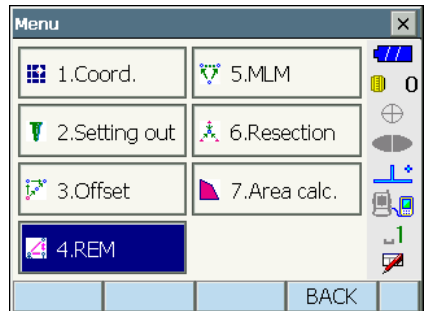

3. Sight the target and press **[MEAS]** to start measurement. Press **[STOP]** to stop the measurement.

Remote elevation	
Need base point obs.	
SD	
ZA	90°50'33"
HA-R	284°31'29"
HT	MEAS

The measured distance data, vertical angle and horizontal angle are displayed.

Remote elevation	
Ht.	
SD	1.663 m
ZA	74°22'51"
HA-R	12°11'09"
HT	MEAS REM

4. Sight the object, then press **[REM]** to start REM measurement is started. The height from the ground to the object is displayed in "Ht.". Press **[STOP]** to stop the measurement.

- To re-observe the target, sight the target then press **[MEAS]**.
- To continue REM measurement, press **[REM]**.

Remote elevation	
Ht. 0.489 m	
SD	1.663 m
ZA	74°22'51"
HA-R	12°11'09"
HT	MEAS REM

Note

- When measurement data already exists, select "REM" in <Menu> as in step 2 to proceed to step 4 and start REM measurement. Press **[STOP]** to stop the measurement.

14.COORDINATE MEASUREMENT

By performing coordinate measurements it is possible to find the 3-dimensional coordinates of the target based on station point coordinates, instrument height, target height, and azimuth angles of the backsight station which are entered in advance.

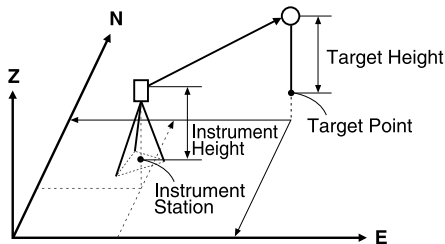

- It is possible to allocate softkeys in measurement menus to suit various applications and the ways that different operators handle the instrument.
☞ "20.6 Allocating Key Functions"

14.1 Entering Instrument Station Data

Before performing coordinate measurement, enter instrument station coordinates and instrument height.



- "Occupy" on the software represents instrument station.

PROCEDURE

1. First measure the instrument height with a tape measure, etc.
2. Select "Coord." in <Menu>.

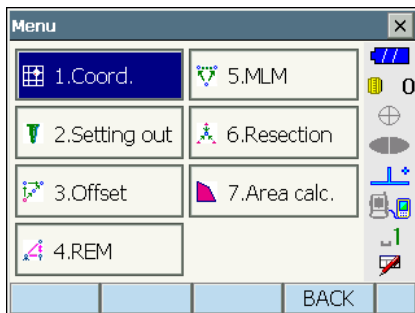

3. Select "Occupy setup" and enter instrument station coordinates, instrument height (HI) and target height (HR).

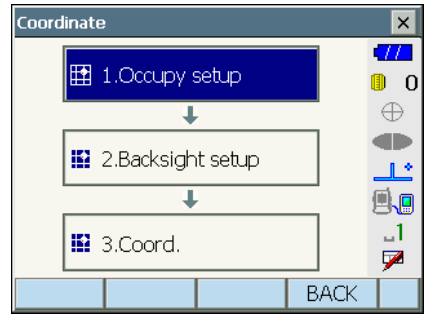

4. Press [OK] to set the input values. <Set H angle> is displayed again.

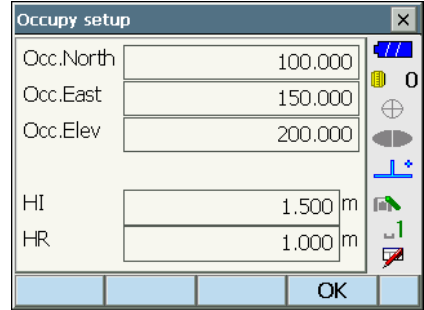

14.2 Azimuth Angle Setting

Based on the instrument station coordinates and backsight station coordinates which have already been set, the azimuth angle of the backsight station is calculated.

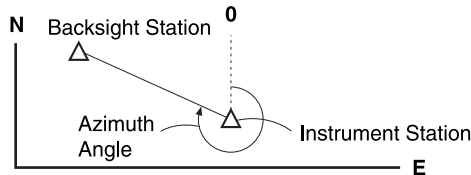

PROCEDURE Entering coordinates

1. Select "Backsight setup" in <Coordinate>. <Set H angle> is displayed.

- <Set H angle> can also be displayed from the screen in step 4 of "14.1 Entering Instrument Station Data".

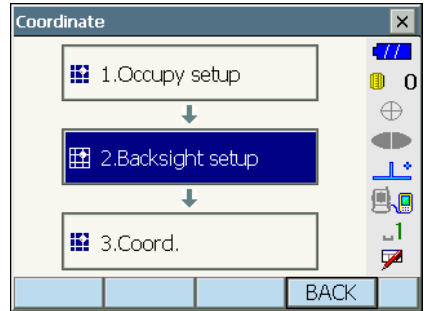

2. Select the "Key in coord" tab and enter the backsight station coordinates.

- **[SRCH]**: Performs Auto Pointing. Rotates the instrument in the direction of the backsight.
- **[Azimuth] / [H.ANG] / [None] / [0 SET]** (in the second page): Switches horizontal angle setting method.

"Horizontal angle settings"

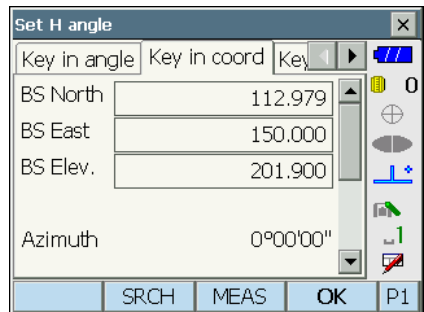

- Sight the backsight station and press **[MEAS]**. Press **[STOP]** to display the distance calculated from coordinates, the measured distance, and the difference between the two. Press **[YES]** to set the azimuth angle and display <Coord. measurement>.

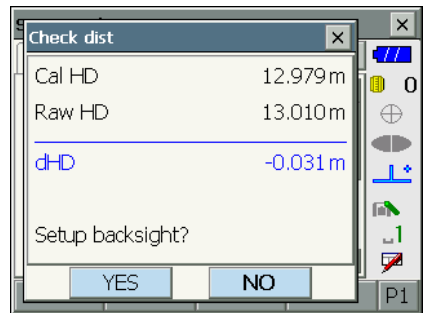

3. Press **[OK]** to set the azimuth angle. <Coord. measurement> is displayed.

PROCEDURE Entering angle

1. Select "Backsight setup" in <Coordinate>. <Set H angle> is displayed.

- <Set H angle> can also be displayed from the screen in step 4 of "14.1 Entering Instrument Station Data".

2. Select the "Key in angle" tab and enter the desired angle in "H.ang".

- **[SRCH]**: Performs Auto Pointing. Rotates the instrument in the direction of the backsight.

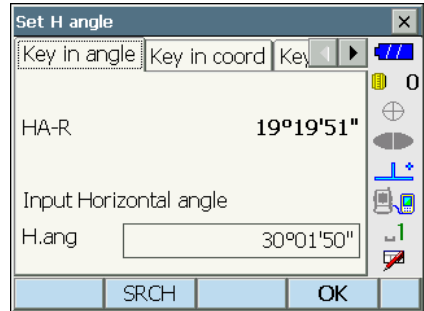

3. Press **[OK]** to set the input values. <Coord. measurement> is displayed.

PROCEDURE Entering azimuth

1. Select "Backsight setup" in <Coordinate>. <Set H angle> is displayed.

- <Set H angle> can also be displayed from the screen in step 4 of "14.1 Entering Instrument Station Data".

2. Select the "Key in azimuth" tab and enter the desired angle in "Azimuth".

- **[SRCH]**: Performs Auto Pointing. Rotates the instrument in the direction of the backsight.
- **[Azimuth] / [H.ANG] / [None] / [0 SET]** (in the second page): Switches horizontal angle setting method.

Horizontal angle settings"

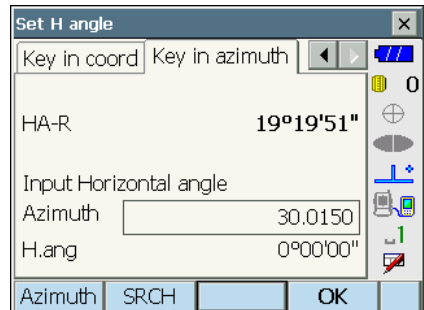

3. Press **[OK]** to set the input values. <Coord. measurement> is displayed.



Horizontal angle settings

Azimuth (set both horizontal and azimuth angles to the same value)/H.ang (input both horizontal and azimuth angles)/None (input azimuth angle only)/0 SET (horizontal angle set to 0°)

14.3 3-D Coordinate Measurement

The coordinate values of the target can be found by measuring the target based on the settings of the instrument station and backsight station.

The coordinate values of the target are calculated using the following formulae.

$$N1 \text{ Coordinate} = N0 + S \times \sin Z \times \cos Az$$

$$E1 \text{ Coordinate} = E0 + S \times \sin Z \times \sin Az$$

$$Z1 \text{ Coordinate} = Z0 + S \times \cos Z + ih - th$$

N0: Station point N coordinate S: Slope distance ih: Instrument height

E0: Station point E coordinate Z: Zenith angle th: Target height

Z0: Station point Z coordinate Az: Direction angle

"Null" coordinates will not be included in calculations. "Null" is not the same as zero.

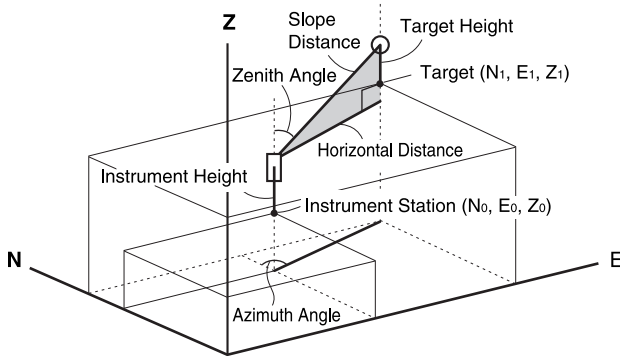

PROCEDURE

1. Sight the target at the target point.

2. Select "Coord." in <Coordinate>.

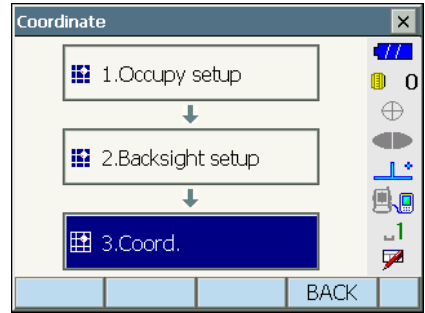

Press **[MEAS]** to start measurement. Press **[STOP]** to stop the measurement. The coordinates of the target point are displayed. Select the "Graphic" tab to display coordinates on a graph.

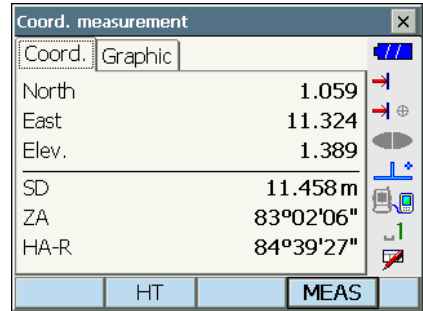

3. Sight the next target and press **[MEAS]** to begin measurement. Continue until all targets have been measured.
4. When coordinate measurement is completed, press **{ESC}** or tap the cross in the top-right corner to return to <Coordinate>.

15. RESECTION MEASUREMENT

Resection is used to determine the coordinates of an instrument station by performing multiple measurements of points whose coordinate values are known. Registered coordinate data can be recalled and set as known point data. Residual of each point can be checked, if necessary.

Entry	Output
Coordinates of known point : (Ni, Ei, Zi)	Station point coordinates : (N0, E0, Z0)
Observed horizontal angle : Hi	
Observed vertical angle : Vi	
Observed distance : Di	

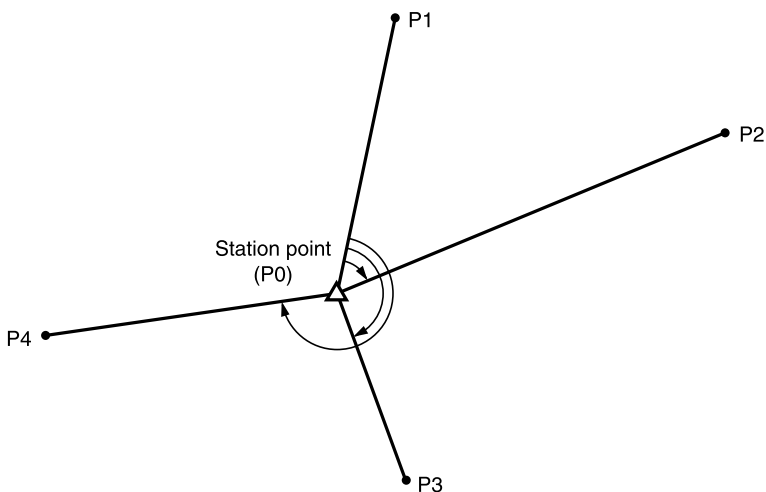

- Between 2 and 10 known points can be measured by distance measurement, and between 3 and 10 known points by angle measurement.
- The more known points there are and the more points there are whose distance can be measured, the higher the precision of the coordinate value calculation.
- It is possible to allocate softkeys in measurement menus to suit various applications and the ways that different operators handle the instrument.

 "20.6 Allocating Key Functions"

15.1 Coordinate Resection Measurement

N, E, Z of an instrument station is determined by the measurement.

PROCEDURE

1. Select "Resection" in <Menu>.

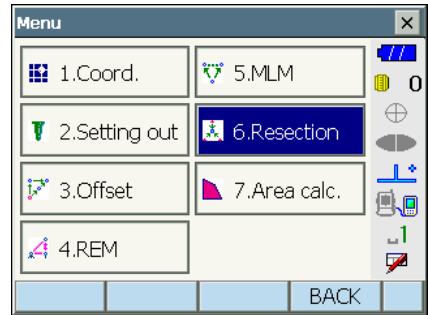

2. Select "NEZ" to display <Resection/Known point>.

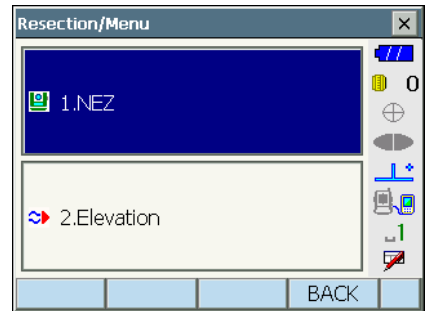

3. Input the known point.
After setting the coordinates and target height for the first known point press **[NEXT]** to move to the second point.

- Press **[PREV]** to return to settings for the previous point.

When all required known points have been set, press **[OK]**.

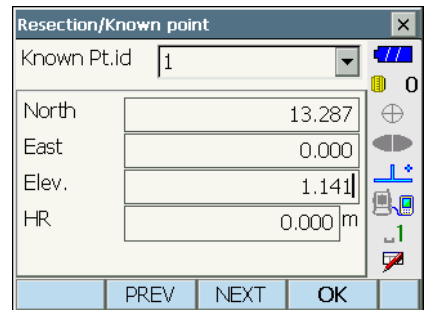

4. Sight the first known point and press **[MEAS]** to begin measurement.
The measurement results are displayed on the screen.

- When **[ANGLE]** has been selected, the distance cannot be displayed.

Resection/observation known points		
Known Pt.id	1	
North	13.287	0
East	0.000	
Elev.	1.141	
SD	13.337 m	
ZA	85°07'44"	
HA-R	359°58'56"	

MEAS

5. Press **[YES]** to use the measurement results of the first known point.

- You can also input target height here.
- Press **[NO]** to return to the screen in step 4 and perform measurement again.

Resection/result		
SD	13.337 m	
ZA	85°07'45"	
HA-R	359°58'56"	
HR	<input type="text" value="0.000"/> m	

YES **NO**

6. Repeat procedures 4 to 5 in the same way from subsequent points.

When the minimum quantity of observation data required for the calculation is present, **[CALC]** is displayed.

[AUTO] will be displayed for the 3rd point onwards for Auto Tracking models. Pressing **[AUTO]** will rotate the instrument to the next point and start auto measurement.

- Press **[STOP]** during auto measurement to display a confirmation message. Press **[YES]** in this message to return to the first point measured using auto measurement. Measurement can now be continued manually. Press **[NO]** to continue measurement manually from the current position.

Resection/result		
SD	14.405 m	
ZA	85°07'21"	
HA-R	27°24'55"	
HR	<input type="text" value="0.000"/> m	

CALC **YES** **NO**

- Press [CALC] or [YES] to automatically start calculations after observations of all known points are completed.

- Instrument station coordinates, station elevation, and standard deviation, which describes the measurement accuracy, are displayed.

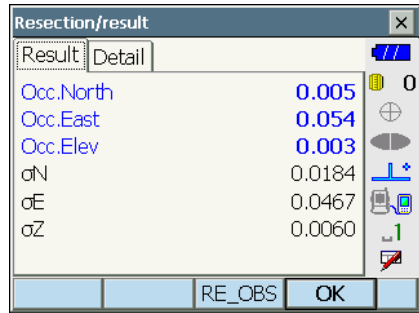

Standard deviation for the northing, easting and elevation coordinates of each point are displayed in the "Detail" tab.

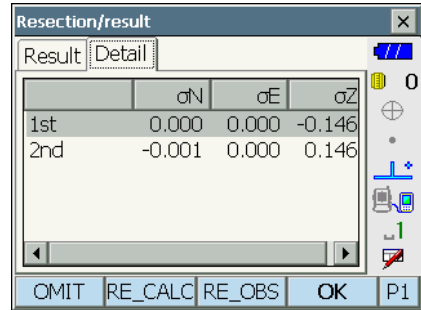

- If there are problems with the results of a point, align the cursor with that point and press [OMIT]. "OMIT" is displayed to the right of the point. Repeat for all results that include problems.

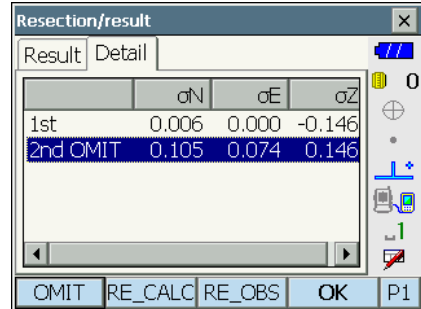

- Press [RE_CALC] to perform calculation again without the point designated in step 8. The result is displayed.
If there are no problems with the result, go to step 10.
If problems with the result occur again, perform the resection measurement from step 4.

- Press [RE OBS] to measure the point designated in step 8.
If no points are designated in step 8, all the points or only the final point can be observed again.

- Press **[ADD]** in the second page when there is a known point that has not been observed or when a new known point is added.

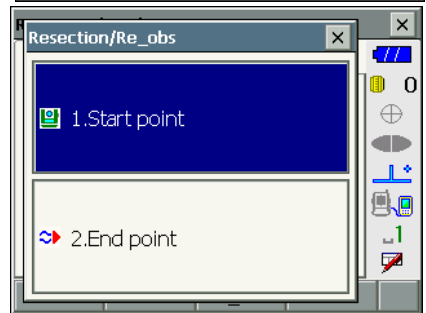
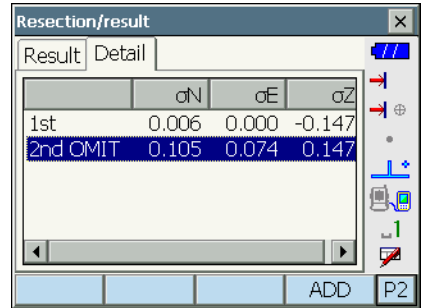

- Press **[OK]** in <Resection/result> to display <Resection/Set h angle>.
- Select an angle mode and press **[YES]** to set the azimuth angle of the first known point as the backsight point and return to <Resection/Menu>.

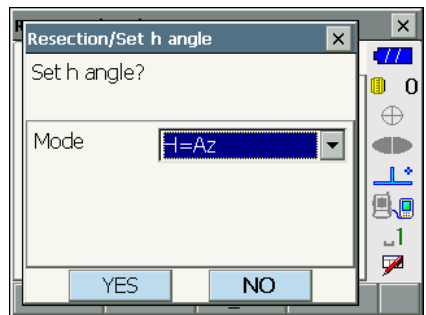

- Press **[NO]** to return to <Resection/Menu> without setting the azimuth angle.



Horizontal angle settings

H (set horizontal angle to measured value)/H=Az (set horizontal angle to the same value as azimuth angle)/Az (set azimuth angle only)



- It is also possible to perform resection measurement by pressing **[RESEC]** in the third page of Observation mode.

15.2 Height Resection Measurement

Only Z (height) of an instrument station is determined by the measurement.

- Known points must be measured by distance measurement only.
- Between 1 and 10 known points can be measured.

PROCEDURE

1. Select "Resection" in <Menu>.
2. Select "Elevation" to display <Resection/Known point>.
3. Input the known point.
After setting the elevation and target height for the first known point press **[NEXT]** to move to the second point.
 - Press **[PREV]** to return to settings for the previous point.

When all required known points have been set, press **[OK]**.

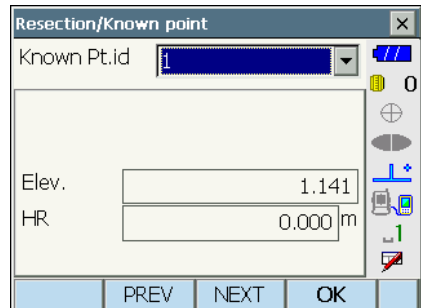
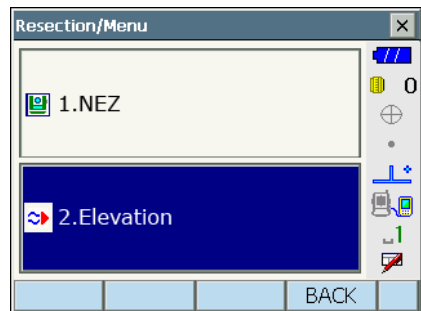
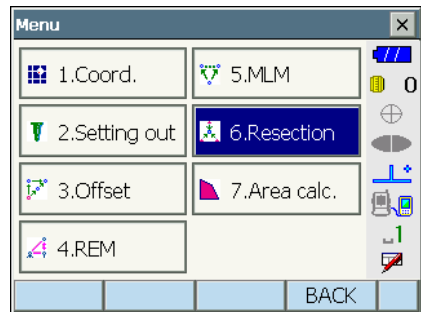

- Sight the first known point and press **[MEAS]** to begin measurement.
The measurement results are displayed on the screen.

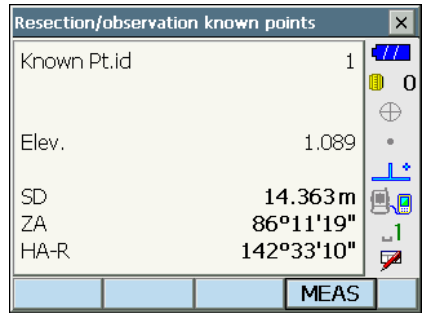

- If measuring two or more known points, repeat procedures 4 in the same way from the second point.

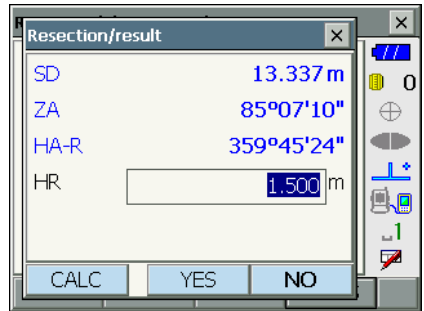

- Press **[CALC]** or **[YES]** to automatically start calculations after observations of all known points are completed.
 - Instrument station elevation and standard deviation, which describes the measurement accuracy, are displayed in the "Result" tab.

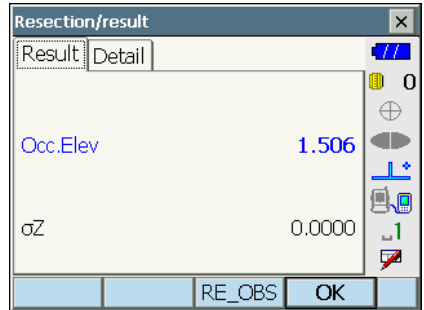

Standard deviation values for each point are displayed in the "Detail" tab.

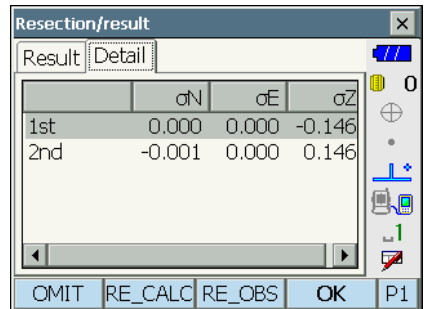

7. If there are problems with the results of a point, align the cursor with that point and press **[OMIT]**. "OMIT" is displayed to the right of the point. Repeat for all results that include problems.

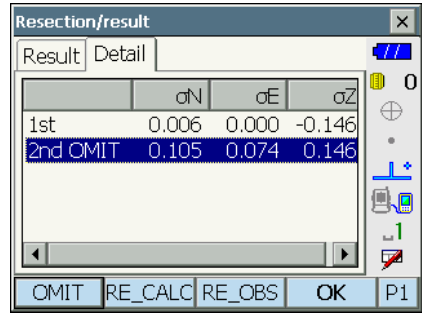

8. Press **[RE CALC]** to perform calculation again without the point designated in step 7. The result is displayed. If there are no problems with the result, go to step 9.

If problems with the result occur again, perform the resection measurement from step 4.

- Press **[RE_OBS]** to measure the point designated in step 7.
- Press **[ADD]** in the second page when there is a known point that has not been observed or when a new known point is added.

If no points are designated in step 7, all the points or only the final point can be observed again.

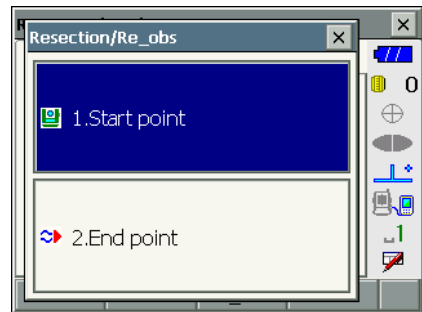

9. Press **[OK]** to finish resection measurement and return to <Resection/Menu>. Only Z (elevation) of the instrument station coordinate is set. N and E values are not overwritten.



Resection calculation process

The NE coordinates are found using angle and distance observation equations, and the instrument station coordinates are found using the method of least squares. The Z coordinate is found by treating the average value as the instrument station coordinates.

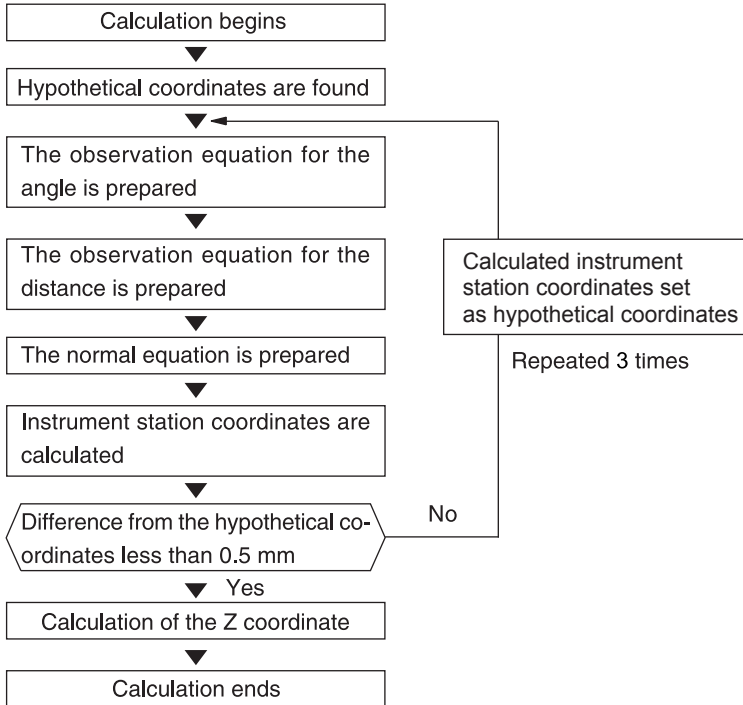



Precaution when performing resection

In some cases it is impossible to calculate the coordinates of an unknown point (instrument station) if the unknown point and three or more known points are arranged on the edge of a single circle.

An arrangement such as that shown below is desirable.

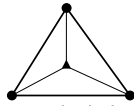

△▲ : Unknown point
○● : Known point

It is sometimes impossible to perform a correct calculation in a case such as the one below.

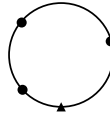

When they are on the edge of a single circle, take one of the following measures.

- (1) Move the instrument station as close as possible to the center of the triangle.

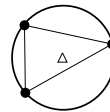

- (2) Observe one more known point which is not on the circle.

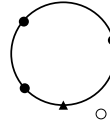

- (3) Perform a distance measurement on at least one of the three points.

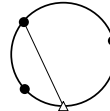

- In some cases it is impossible to calculate the coordinates of the instrument station if the included angle between the known points is too small. It is difficult to imagine that the longer the distance between the instrument station and the known points, the narrower the included angle between the known points. Be careful because the points can easily be aligned on the edge of a single circle.

16.SETTING-OUT MEASUREMENT

Setting-out measurement is used to set out the required point.

The difference between the previously input data to the instrument (the setting-out data) and the measured value can be displayed by measuring the horizontal angle, distance or coordinates of the sighted point.

The horizontal angle difference distance difference, and coordinate difference are calculated and displayed using the following formulae.

Horizontal difference

Displayed value (angle) = Horizontal angle of setting-out data - measured horizontal angle

Displayed value (distance) = measured horizontal distance x tan (horizontal angle of setting out data - measured horizontal angle)

Slope distance difference

Displayed value (slope distance) * = measured slope distance - slope distance setting-out data

* Horizontal distance or height difference can be input in the above formula.

Coordinate difference

Displayed value (coordinates)* measured N setting-out coordinates - N coordinates of setting-out data

* E or Z coordinates can be input in the above formula

Height difference (REM setting out measurement)

Displayed value (height) = measured REM data - REM data of setting out data

- Setting out data can be input in various modes: slope distance, horizontal distance, height difference, coordinates and REM measurement.
- It is possible to allocate softkeys in the Setting-out measurement menu to suit various applications and the ways that different operators handle the instrument.
 "20.6 Allocating Key Functions"



- [AT On] can only be selected on the Auto Tracking model.

16.1 Using the Guide Light in Setting-out Measurement

When the guide light is set to ON, the flashing speed of the light indicates the status of the instrument and can be known when the user is located at a distance from the instrument. Also, the flashing colors relative to the target indicate the direction of the instrument and allow the user to reposition the target.
 Turning the Guide light ON/OFF: "5.1 Basic Key Operation"

- The pattern of the guide light can be changed.
 "20.2 Instrument Configuration"

● **Guide light status and meaning**

Status of instrument

Light status	Meaning
Slow flashing (Red and green simultaneously)	Waiting
	Search error (error screen only)
Fast flashing (Red and green simultaneously)	Searching in progress
	Measuring (continuous measurement)
	Returned signal checking in progress
	Auto Tracking in progress (Auto Tracking model only)
	Auto Tracking in predicted direction (Auto Tracking model only)
Green and red alternate flashing	Distance measurement error (no signal, sighting error)
	"Prism wait"

Indication for positioning target during setting-out measurement

Light status	Meaning
Increased flashing speed	(From position of poleman) Move target toward instrument
Decreased flashing speed	(From position of poleman) Move target away from instrument
Fast flashing	Target is at correct distance
Red	(From position of poleman) Move target left
Green	(From position of poleman) Move target right
Red and Green	Target is at correct horizontal position

16.2 Distance Setting-out Measurement

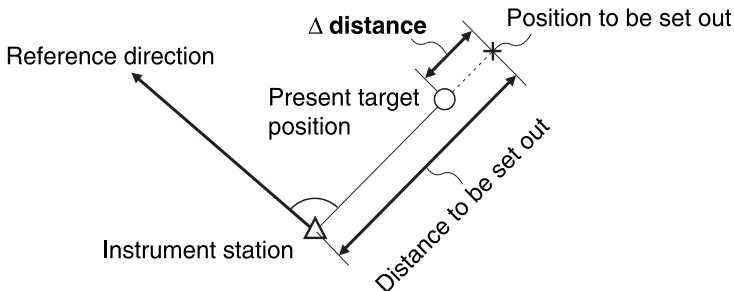

The point is to be found based on the horizontal angle from the reference direction and the distance from the instrument station.

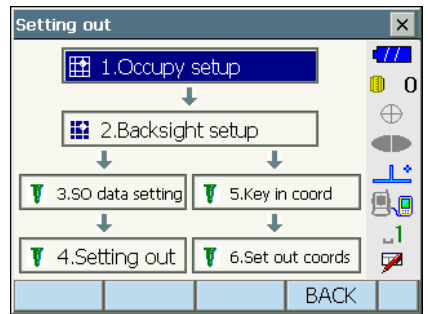
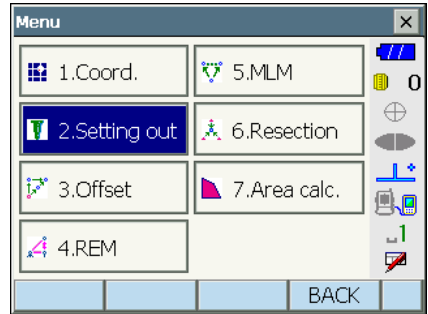

PROCEDURE

1. Select "Setting out" in <Menu> to display <Setting out>.



2. Select "Occupy setup" to display <Occupy setup>. Enter data for the instrument station and press **[OK]** to move to Backsight setup.
 "14.1 Entering Instrument Station Data"
3. Set the azimuth angle for the backsight station.
 Press **[OK]** to return to <Setting out>.
 "14.2 Azimuth Angle Setting"

Reference Direction

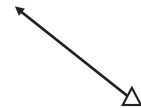

Instrument station

4. Select "SO data setting" In <Setting out> to display <SO data setting>. In the distance mode that conforms to your measurement requirements, enter the included angle between the reference point and the setting-out point in "SO.H.ang", and the distance (slope distance, horizontal distance or height difference) from the instrument station to the position to be set out in "SO.Sdist".

- Each time [**Shvr**] is pressed, the distance mode changes from "SD" (slope distance), "HD" (horizontal distance), "VD" (height difference), and "Ht." (REM).
 - Press [**COORD**] in the second page and input coordinates in <Key in coord>. The angle and distance from these coordinates to the position to be set out will be calculated.
5. Enter values and press [**OK**] to display the screen at right.
Press [**H.TURN**] to automatically rotate the instrument until the difference in horizontal angle to the setting out point reads 0°.

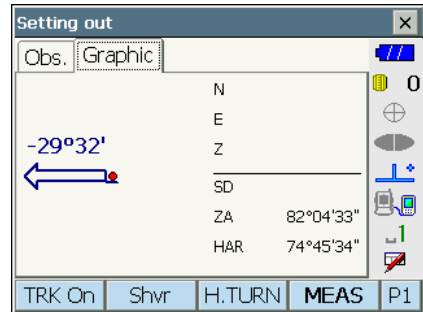
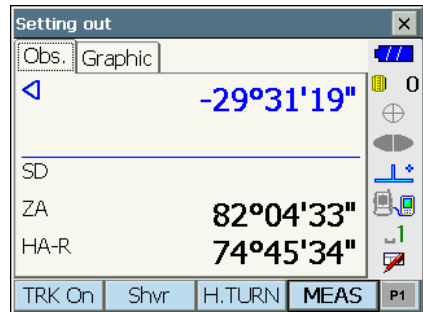
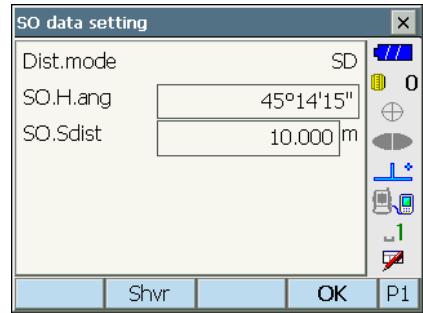

- Press **[CNFG]** to set setting out accuracy. When the position of the target is within this range both arrows will be displayed to indicate that the target position is correct.

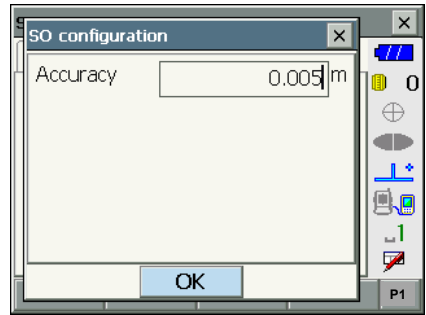

6. Position the target on the line of sight and press **[MEAS]** to begin distance measurement. The distance and direction to move the target until the setting out point is located is displayed on the instrument. The sighting point measurement results (currently installed position of the target) are displayed.

Arrows indicate direction to move

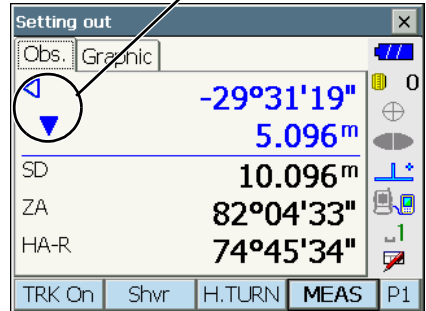

- Movement indicator (Red indicates that target position is correct)
 - ◁ : (Viewed from instrument) Move target to the left
 - ▷ : (Viewed from instrument) Move target to the right
 - ◁▷ : Target position is correct
 - ▼ : (Viewed from instrument) Move target closer
 - ▲ : (Viewed from instrument) Move target away
 - ▲▼ : (Viewed from instrument) Target position is correct
 - ▲↑ : Move target upward
 - ▼↓ : Move target downward
 - ▲▼ : Target position is correct

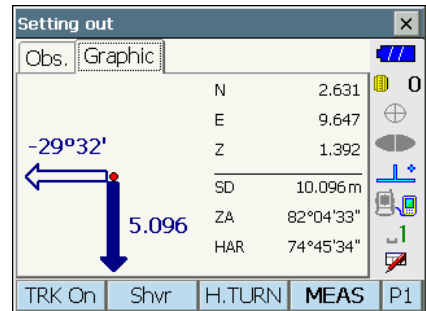

- Each time **[Shvr]** is pressed, the distance mode changes from "SD" (slope distance), "HD" (horizontal distance), "VD" (height difference), and "Ht." (REM).
- Press **[CNFG]** to set setting out accuracy. When the position of the target is within this range both arrows will be displayed to indicate that the target position is correct.

7. Move the target until the distance to the setting-out point reads 0m. When the target is moved within the allowed range, all distance and position arrows are displayed.

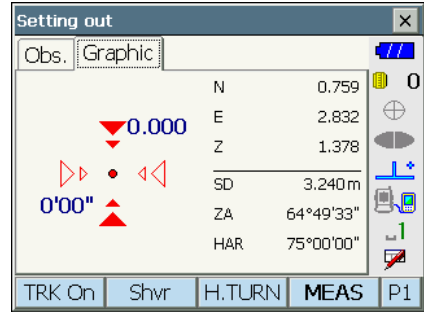
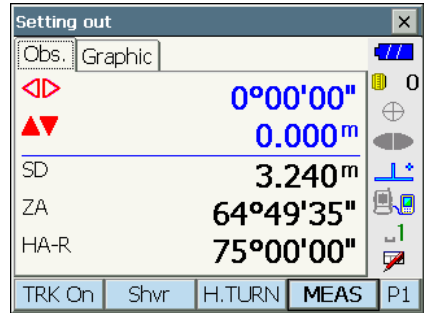

8. Press **{ESC}** to return to <Setting out>. Set the next setting out point to continue setting out measurement.

16.3 Coordinates Setting-out Measurement

After setting the coordinates for the point to be set out, the instrument calculates the setting-out horizontal angle and horizontal distance. By selecting the horizontal angle and then the horizontal distance setting-out functions, the required coordinate location can be set out.

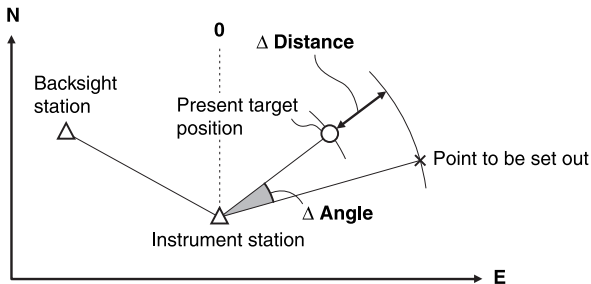

- Previously recorded setting-out points can be placed in order. Up to 50 points can be recorded.
- To find the Z coordinate, attach the target to a pole etc. with the same target height.

PROCEDURE

1. Select "Setting out" in <Menu> to display <Setting out>.
2. Select "Occupy setup" to display <Occupy setup>. If necessary, enter data for Backsight setup.
 "16.2 Distance Setting-out Measurement" steps 2 to 3

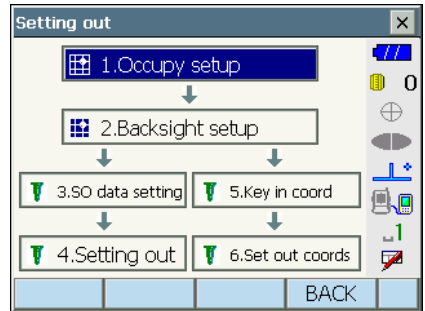

3. Select "Key in coord" in <Setting out>. Record all the setting-out points (includes setting-out points you will measure from now).
Press **[ADD]** to record new data.

- Press **[DEL]** in the second page to delete the selected setting out point.
- Press **[DELALL]** in the second page to delete all setting out points.

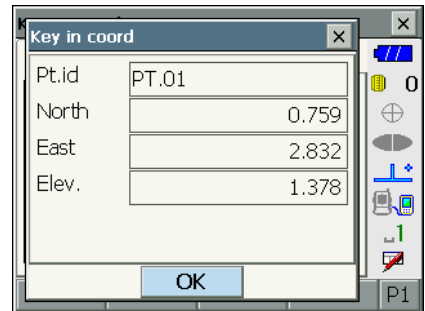
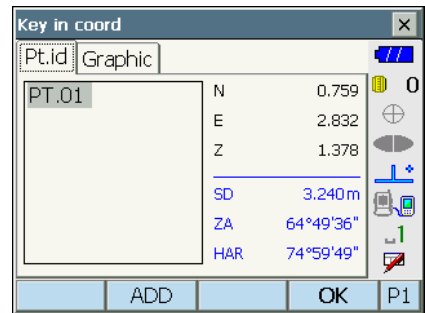

4. Select a setting-out point in the first screen of step 3 and press **[OK]** to display <Set out Coords>.

5. Position the target on the line of sight and press **[H.TURN]** to automatically rotate the instrument until the angle of the setting out point reads 0°.

[MEAS] to begin distance measurement.

The distance and direction to move the target until the setting out point is located is displayed on the instrument. The sighting point measurement results (currently installed position of the target) are displayed.

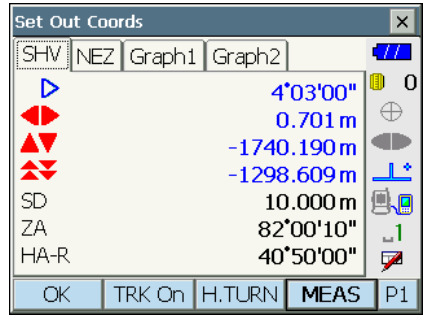

- Switch between the tabs to display different sets of information.

The Graph 1 tab shows the current position of the mirror and the direction to the setting out point from this position.

The Graph 2 tab shows the position of the setting out point (square) and the current location of the mirror (circle).

Height difference direction
Position of poleman

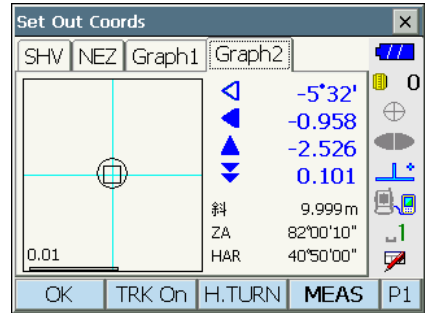
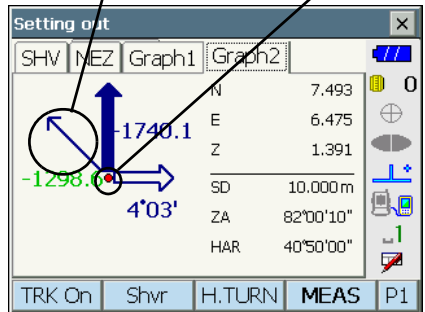

Move the target to find the correct distance (0 is displayed) to the setting out point.

☞ Movement indicators: "16.2 Distance Setting-out Measurement" step 6

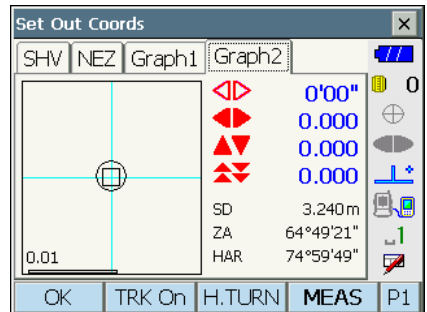
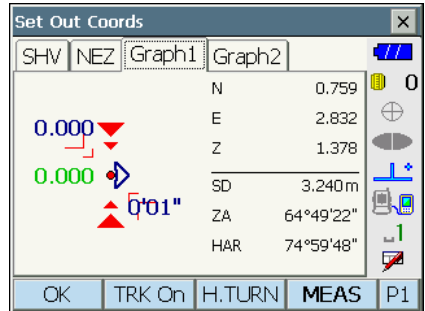
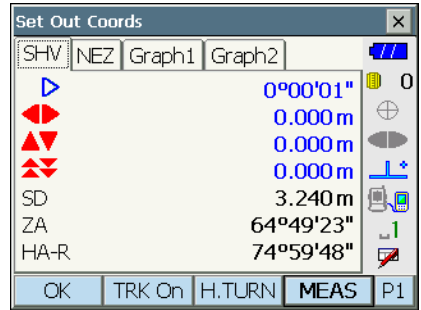

- Press **{ESC}** to return to <Key in coord>. Set the next setting out point to continue setting out measurement.

16.4 REM Setting-out Measurement

To find a point where a target cannot be directly installed, perform REM setting-out measurement.

☞ "13.5 REM Measurement"

PROCEDURE

1. Install a target directly below or directly above the point to be found. Then use a measuring tape etc. to measure the target height (height from the surveying point to the target).
2. Select "Occupy setup" in <Setting out> to display <Occupy setup>. If necessary, enter data for Backsight setup.
☞ "16.2 Distance Setting-out Measurement" steps 2 to 3
3. Select "SO data setting" In <Setting out> to display <SO data setting>. Press [**Shvr**] until the distance input mode is "SO.Height.". Input height from the surveying point to the position to be set out in "SO.Height.". If necessary, input the angle to the point to be set out.
4. Enter values and press [**OK**] in step 3 to display the screen at right.
Press [**H.TURN**] to automatically rotate the instrument until the angle of the setting out point reads 0°.

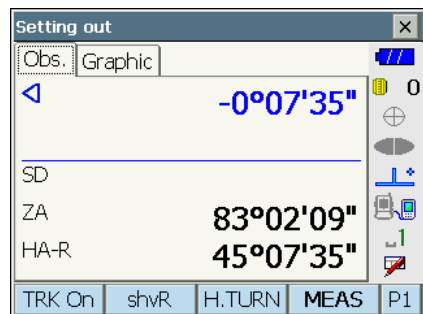
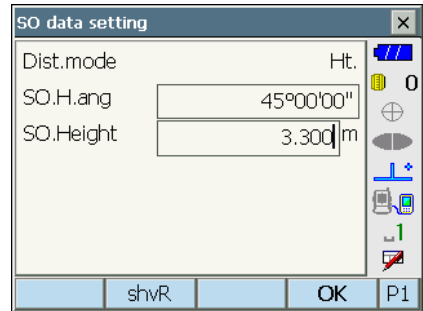

- Sight the target and press **[MEAS]**. Measurement begins and the measurement results are displayed.

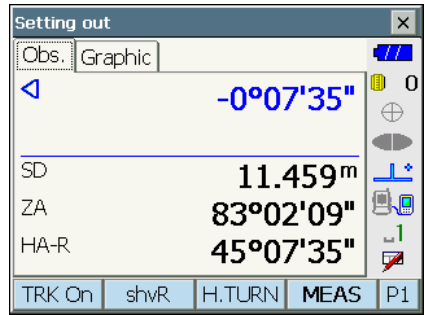

- Press **[REM]** to start REM measurement. The distance (height difference) and direction to move the target until the sighting point and setting out point are located is displayed on the instrument.

Arrows indicate direction to move

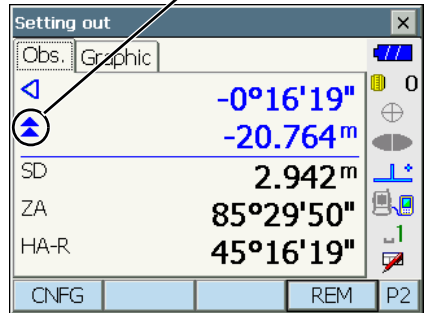

Press **[STOP]** to stop measuring.

Find the setting-out point by moving the telescope until the distance to the setting-out point reads 0m.

- Movement indicator (Red indicates that target position is correct)

- ▲ : Move the telescope near the zenith
- ▼ : Move the telescope near the nadir
- ↕ : Telescope direction is correct
- ☞ For details of other movement indicators: "16.2 Distance Setting-out Measurement" step 6

- Press **[CNFG]** to set setting out accuracy. When the position of the target is within this range both arrows will be displayed to indicate that the target position is correct.

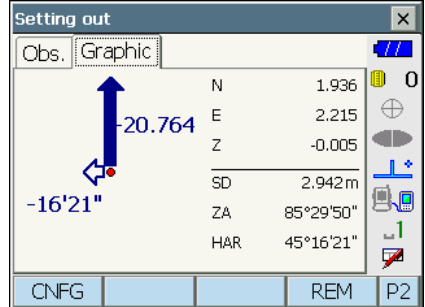

- Press **[ESC]** to return to <SO data setting>.

17.OFFSET MEASUREMENT

Offset measurements are performed in order to find a point where a target cannot be installed directly or to find the distance and angle to a point which cannot be sighted.

- It is possible to find the distance and angle to a point you wish to measure (target point) by installing the target at a location (offset point) a little distance from the target point and measuring the distance and angle from the survey point to the offset point.
- The target point can be found in the three ways explained in this chapter.
- The instrument station and backsight must be set before the coordinates of an offset point can be found. Station and backsight setup can be performed in the Offset menu.
☞ Occupy setup: "14.1 Entering Instrument Station Data", Backsight setup: "14.2 Azimuth Angle Setting".
- It is possible to allocate softkeys in measurement menus to suit various applications and the ways that different operators handle the instrument.
☞ "20.6 Allocating Key Functions"

17.1 Offset Single-distance Measurement

Finding it by entering the horizontal distance from the target point to the offset point.

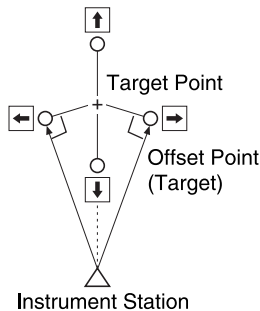

- When the offset point is positioned to the left or right of the target point, make sure the angle formed by lines connecting the offset point to the target point and to the instrument station is almost 90° .
- When the offset point is positioned in front of or behind the target point, install the offset point on a line linking the instrument station with the target point.

PROCEDURE

1. Set the offset point close to the target point and measure the distance between them, then set up a prism on the offset point.

2. Select "Offset" in <Menu> to display <Offset>.

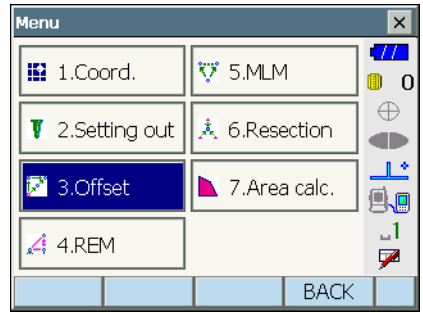

3. Select "Occupy setup" to display <Occupy setup>. Enter data for the instrument station and press [OK] to move to Backsight setup.
 [F7] "14.1 Entering Instrument Station Data"

Reference Direction

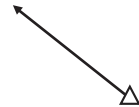

Instrument station

4. Set the azimuth angle for the backsight station. Press [OK] to return to <Offset>.
 [F7] "14.2 Azimuth Angle Setting"

5. Select "OffsetDIST".
 Input the following items.
 (1) Direction of the offset point.
 (2) Horizontal distance from the target point to the offset point.

• Direction of offset point

- ← : On the left of the target point.
- : On the right of the target point.
- ↓ : Closer than the target point.
- ↑ : Beyond the target point.

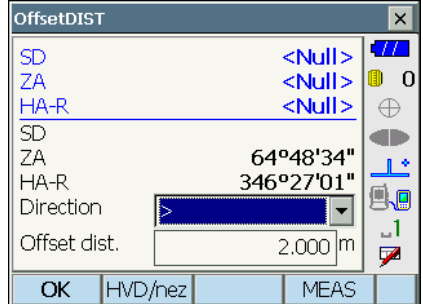
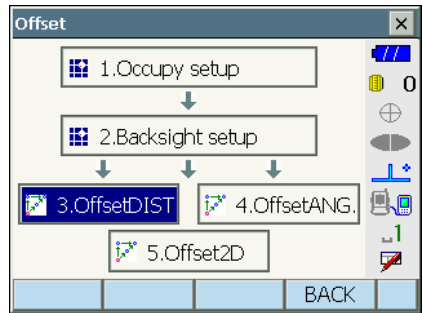

6. Sight the offset point and press **[MEAS]** in the screen of step 3 to start measurement. Press **[STOP]** to stop the measurement. The measurement results are displayed.

- Press **[HVD/nez]** to switch results for the target point between distance/angle values and coordinate/elevation values.

Results for target point

OffsetDIST	
SD	2.594 m
ZA	83°55'42"
HA-R	295°37'36"
SD	1.652 m
ZA	80°26'34"
HA-R	359°39'28"
Direction	>
Offset dist.	2.000 m
<input type="button" value="OK"/> <input type="button" value="HVD/nez"/> <input type="button" value="MEAS"/>	

Results for offset point

17.2 Offset Angle Measurement

Sighting the direction of the target point to find it from the included angle.

Install offset points for the target point on the right and left sides of and as close as possible to the target point and measure the distance to the offset points and the horizontal angle of the target point.

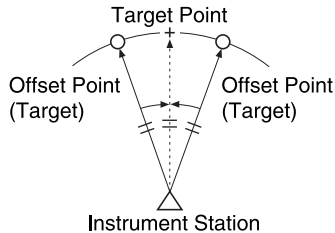

PROCEDURE

1. Set the offset points close to the target point (making sure the distance from the instrument station to the target point and the height of the offset points and the target point are the same), then use the offset points as the target.

2. Select "Offset" in <Menu> to display <Offset>.

Select "OffsetANG."

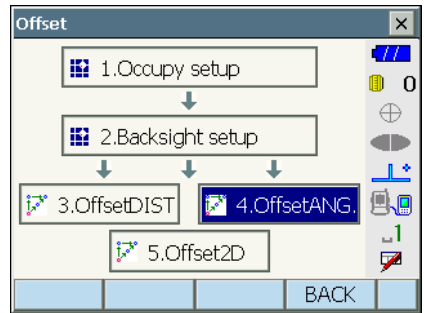

3. Sight the offset point and press **[MEAS]** to start measurement.
Press **[STOP]** to stop the measurement.

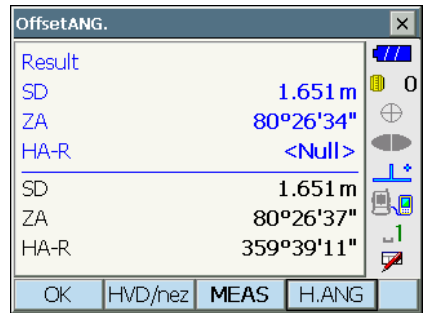

4. Sight the target point and press **[H.ANG]**.

- Press **[HVD/nez]** to switch results for the target point between distance/angle values and coordinate/elevation values.

Results for target point

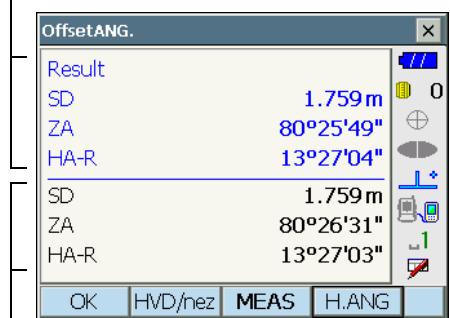

Results for offset point

5. Press **[OK]** in the screen in step 4 to return to <Offset>.

17.3 Offset Two-distance Measurement

By measuring the distances between the target point and the two offset points.

Install two offset points (1st target and 2nd target) on a straight line from the target point, observe the 1st target and 2nd target, then enter the distance between the 2nd target and the target point to find the target point.

- It is possible to make this measurement easily using the optional equipment: the 2-point target (2RT500-K). When using this 2-point target, be sure to set prism constant correction value to 0.  "24. PRISM SYSTEM"

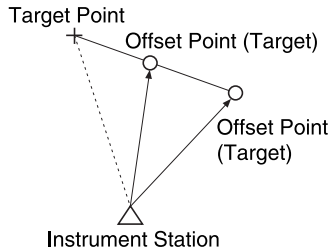

How to use 2-point target (2RT500-K)

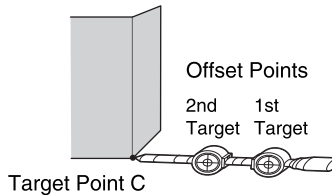

- Install the 2-point target with its tip at the target point.
- Face the targets toward the instrument.
- Measure the distance from the target point to the 2nd target.
- Set the prism constant correction value to 0mm.

Note

- The target should be sighted manually when performing two-distance offset measurement. Multiple prisms in the field will mean that Auto Pointing may not operate correctly, or the instrument may not be able to judge which is the desired target.

 "11.1 Auto Tracking Settings"

PROCEDURE

1. Install two offset points (1st target, 2nd target) on a straight line from the target point and use the offset points as the target.

2. Select "Offset" in <Menu> to display <Offset>.

Select "5.Offset2D".

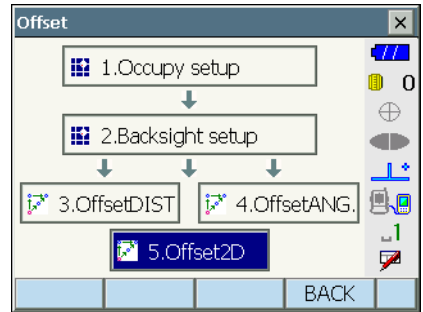

3. Press **[CNFG]** and input the distance from the 2nd target to the target point in "Offset dist.". Set reflector settings and press **[OK]** to confirm.

- Press **[LIST]** to edit the prism constant correction value and aperture in <Reflector setting>.

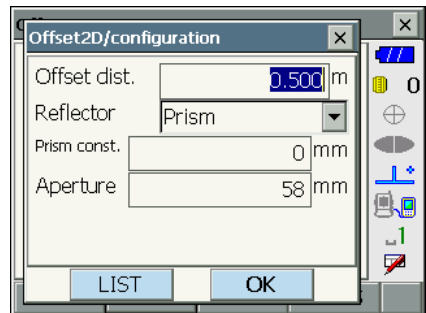

4. Sight the 1st target and press **[MEAS]** to start measurement. Press **[STOP]** to stop the measurement. The measurement results are displayed. Press **[YES]** to confirm.

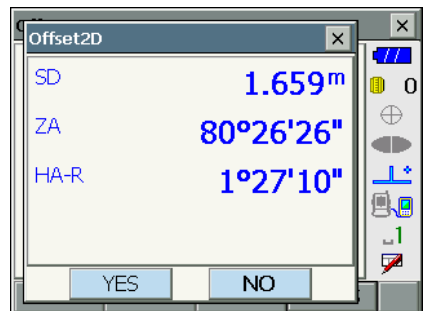

5. Sight the 2nd target and press **[MEAS]** to start measurement.
 Press **[STOP]** to stop the measurement. The measurement results are displayed.

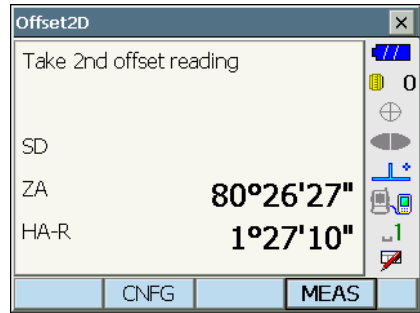

6. Press **[YES]** to display results for the target point.
 Press **[HVD/nez]** to switch results for the target point between distance/angle values and coordinate/elevation values.

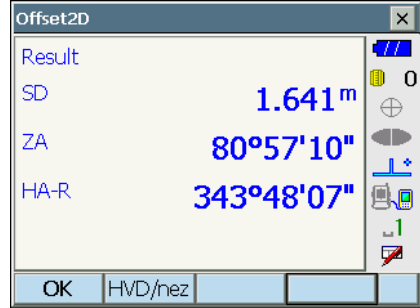

18.MISSING LINE MEASUREMENT

Missing line measurement is used to measure the slope distance, horizontal distance, and horizontal angle to a target from the target which is the reference (starting point) without moving the instrument.

- It is possible to change the last measured point to the next starting position.
- Measurement results can be displayed as the gradient between two points.

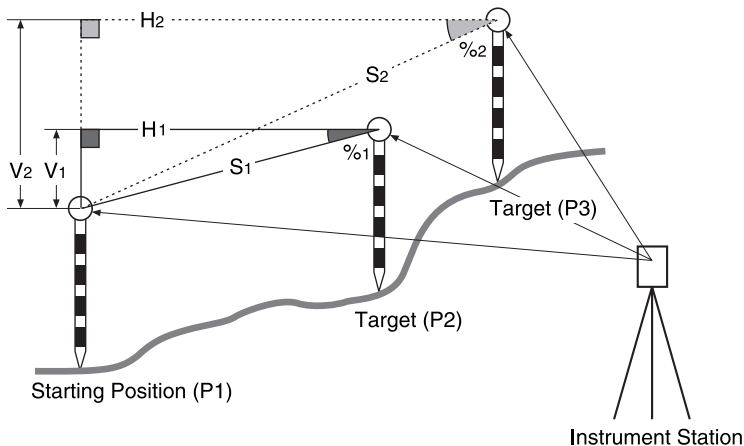

- It is possible to allocate softkeys in measurement menus to suit various applications and the ways that different operators handle the instrument.

"20.6 Allocating Key Functions"

18.1 Measuring the Distance between 2 or more Points

PROCEDURE

1. Select "MLM" in <Menu>.

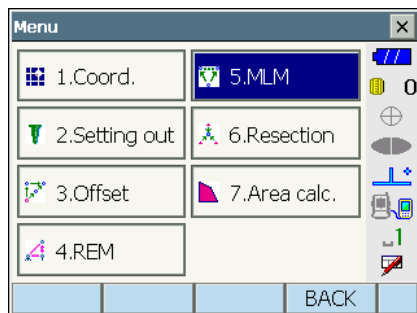

2. Sight the starting position, and press **[MEAS]** to start measurement.
Press **[STOP]** to stop measurement.



- When measurement data already exists the screen of step 3 is displayed and measurement starts.

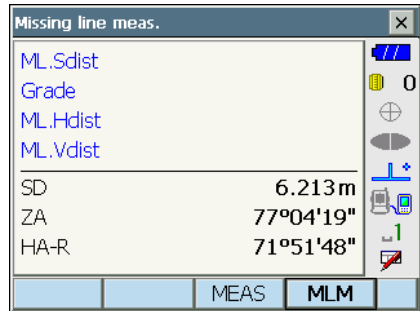
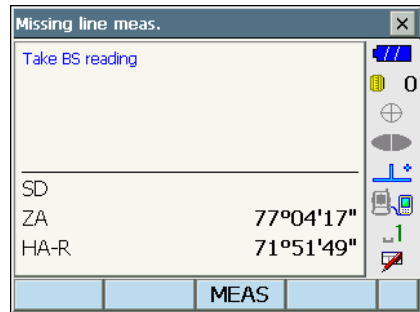

3. Sight the next target and press **[MLM]** to begin observation. Slope distance, grade, horizontal distance and height difference between multiple points and the starting position can be measured this way.

- Press **[MEAS]** to re-observe the starting position. Sight the starting position and press **[MEAS]**.
- When **[MOVE]** is pressed, the last target measured becomes the new starting position to perform missing line measurement of the next target.

"18.2 Changing the Starting Point"

Results for measurement between starting position and second target

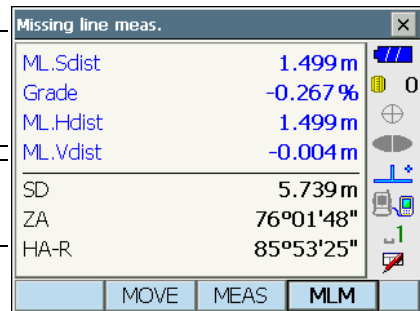

Results for current point

4. Press **[ESC]** or tap the cross in the top-right corner to end missing line measurement.

18.2 Changing the Starting Point

It is possible to change the last measured point to the next starting position.

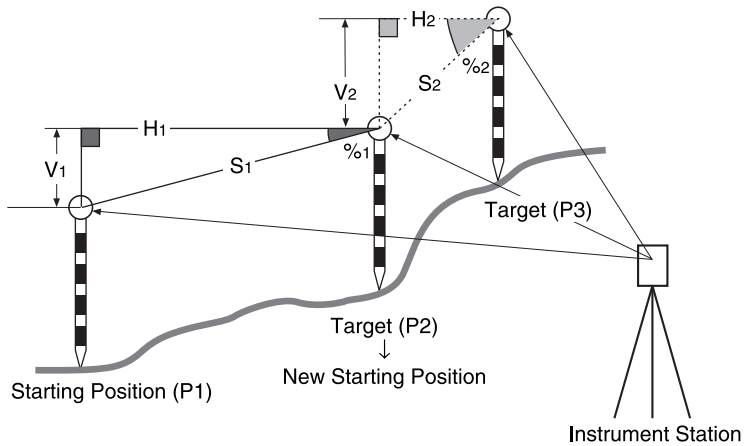

PROCEDURE

1. Observe the starting position and target following steps 1 to 3 in "18.1 Measuring the Distance between 2 or more Points".
2. After measuring the targets, press **[MOVE]**.

Missing line meas.	
ML.Sdist	1.499 m
Grade	-0.267 %
ML.Hdist	1.499 m
ML.Vdist	-0.004 m
SD	5.739 m
ZA	76°01'48"
HA-R	85°53'25"
<div style="display: flex; justify-content: space-between; width: 100%;"> MOVE MEAS MLM </div>	

Press **[YES]** in the confirmation message window.

- Press **[NO]** to cancel measurement.

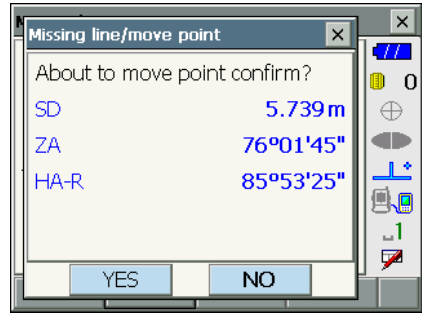

3. The last target measured is changed to the new starting position.
4. Perform missing line measurement following steps 3 to 4 in "18.1 Measuring the Distance between 2 or more Points".

19.SURFACE AREA CALCULATION

You can calculate the area of land (slope area and horizontal area) enclosed by three or more known points on a line by inputting the coordinates of the points

Input

Coordinates: P1 (N1, E1, Z1)

...

P5 (N5, E5, Z5)

Output

Surface area: S (horizontal area and slope area)

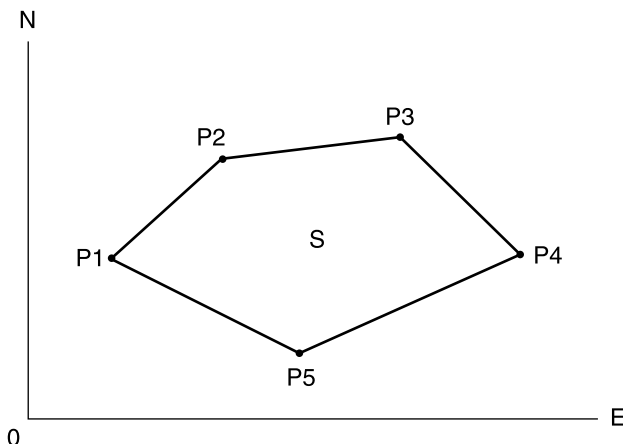

- Number of specified coordinate points: 3 or more, 30 or less
- Surface area is calculated by observing in order the points on a line enclosing an area or by reading in the previously registered coordinates and using it as known point data.
- It is possible to allocate softkeys in measurement menus to suit various applications and the ways that different operators handle the instrument.
☞ "20.6 Allocating Key Functions"



- An error will occur if only two points (or less) are entered (or recalled) when specifying an enclosed area.
- Be sure to observe (or recall) points on an enclosed area in a clockwise or counterclockwise direction. For example, the area specified by entering (or recalling) point numbers 1, 2, 3, 4, 5 or 5, 4, 3, 2, 1 implies the same shape. However, if points are not entered in numerical order, the surface area will not be calculated correctly.



Slope area

The first three points specified (measured/read-in) are used to create the surface of the slope area. Subsequent points are projected vertically onto this surface and the slope area calculated.

PROCEDURE Surface area calculation by measuring points

1. Select "Area calc." in <Menu>

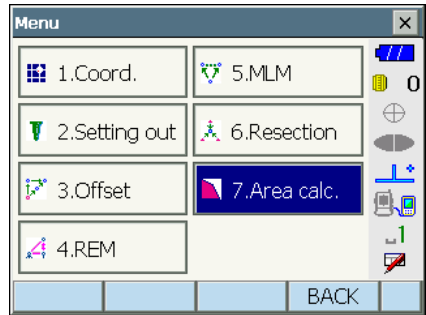

2. Press **[OBS]** to display <Area calculation/ measurement>. Sight the first point on the line enclosing the area, and press **[MEAS]**. Measurement begins and the measured values are displayed. Press **[STOP]** to stop measuring.

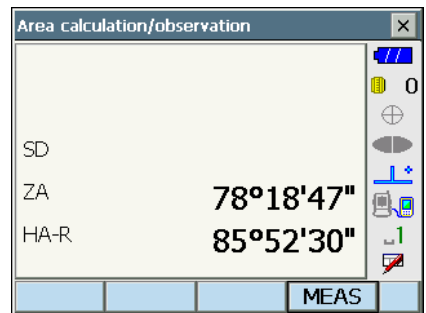
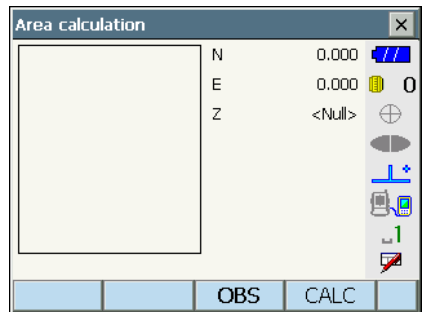

- The measurement results are displayed. Press **[YES]** to confirm. The value of point 1 is set in "Pt_01".

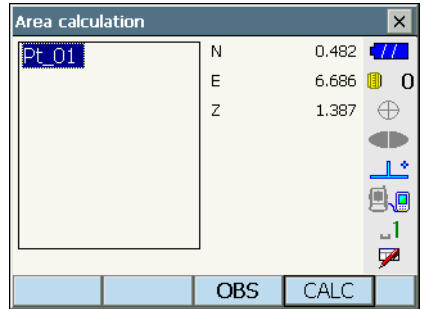
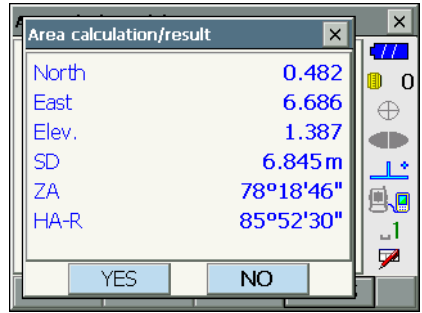

- Repeat steps 2 to 3 until all points have been measured. Points on an enclosed area are observed in a clockwise or counterclockwise direction. For example, the area specified by entering point numbers 1, 2, 3, 4, 5 or 5, 4, 3, 2, 1 implies the same shape.

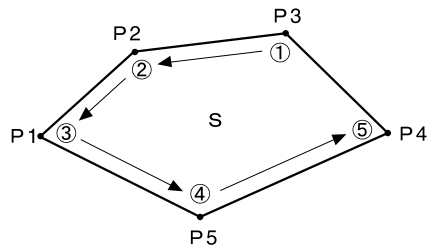

5. Press **[CALC]** to display the calculated area.

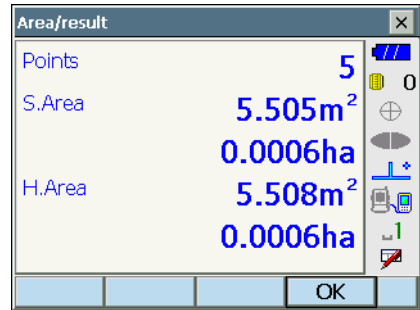
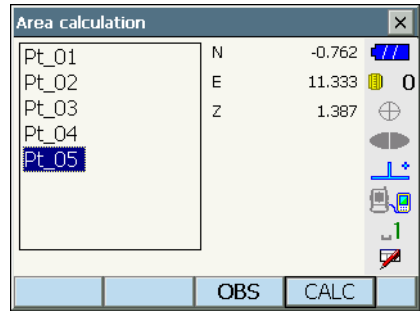

6. Press **[OK]** to return to <Area/key in coord.>. Press **{ESC}** or tap the cross in the top-right corner to quit area calculation.

20.CHANGING THE SETTINGS

This section explains the contents of parameter settings in Basic mode and how to change these settings.

Each item can be changed to meet your measurement requirements.

<Configuration> can be accessed by pressing the "CONFIG" icon in <Top>.

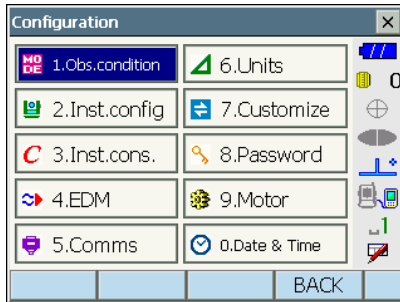

The following chapters provide details of items in Configuration mode.

- Communication settings "9. CONNECTING TO EXTERNAL DEVICES"
- Motor settings "10.1 Auto Pointing Settings", "11.1 Auto Tracking Settings"
- Instrument configurations "22.2 Tilt Sensor", "22.3 Collimation", "22.5 Image Sensor Reticle"

20.1 Observation Conditions

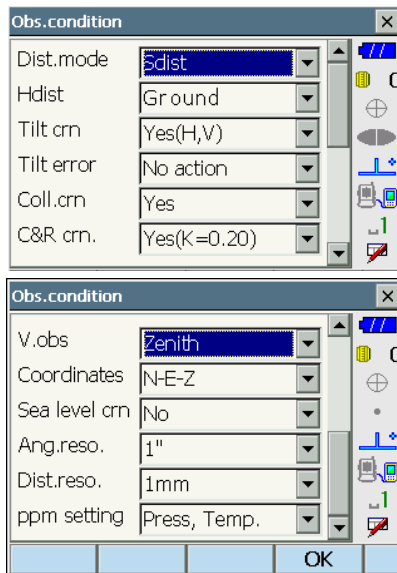

Items set and options (*: Factory setting)

Distance mode	: Sdist (slope distance)*, Hdist (horizontal distance), V.dist (height difference)
Hdist <input type="checkbox"/>	: Ground*, Grid
Tilt crn (tilt correction) <input type="checkbox"/>	: Yes (H,V)*, No, Yes (V)
Tilt error	: No action*/Go to Tilt screen
Coll.crn. (collimation correction) <input type="checkbox"/>	: No, Yes*
C&R crn.	: No, Yes(K=0.142),Yes(K=0.20)*
V manual	: No*, Yes
V.obs (vertical angle display method) <input type="checkbox"/>	: Zenith*, Horiz., Horiz ±90
Coordinates	: N-E-Z*, E-N-Z
Sea level crn. (Sea level correction) <input type="checkbox"/>	: Yes, No*
Ang.reso. (Angle resolution)	: PS-101A/101AC/102A/102AC: 0.5", 1"* PS-103A/103AC/105A/105AC: 1"*, 5"
Dist.reso. (Distance resolution)	: PS-101A/101AC/102A/102AC: 0.1mm, 1mm* PS-103A/103AC/105A/105AC: 1mm*
ppm setting	: Press, Temp.*, +Humidity

 Setting "V manual" to "Yes": "27.2 Manually Indexing the Vertical Circle by Face Left, Face Right Measurement"

 **Hdist**

The instrument calculates horizontal distance using slope distance values. Horizontal distance display can be selected from the following methods.

- Ground: Distance without sea level correction
- Grid: Distance on the rectangular coordinates system calculated by sea level correction
(When "Sea level crn." is set to "No", Distance on the rectangular coordinates system without correction)

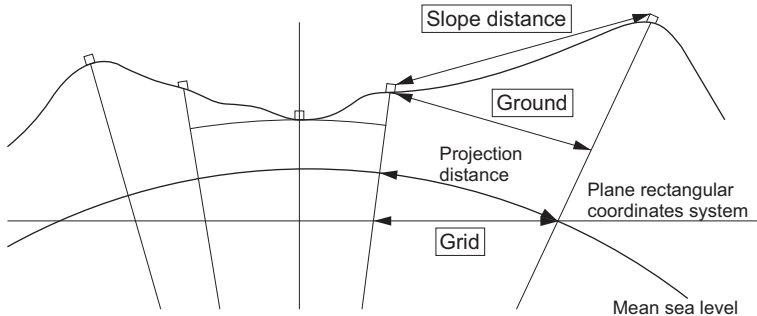



Automatic tilt angle compensation mechanism

The vertical and horizontal angles are automatically compensated for small tilt errors using the 2-axis tilt sensor.

- Read the automatically compensated angles when the display has stabilized.
- The horizontal angle error (vertical axis error) fluctuates according to the vertical axis, so when the instrument is not completely leveled, changing the vertical angle by rotating the telescope will cause the displayed horizontal angle value to change.
- Compensated horizontal angle = Measured horizontal angle + Tilt in angle/tan (Vertical angle)
- When the telescope is directed close to the zenith or nadir angle, tilt compensation is not applied to the horizontal angle.



Collimation correction

The instrument has a collimation correction function that automatically corrects horizontal angle errors caused by horizontal axis and leveling axis errors.



V mode (vertical angle display method)

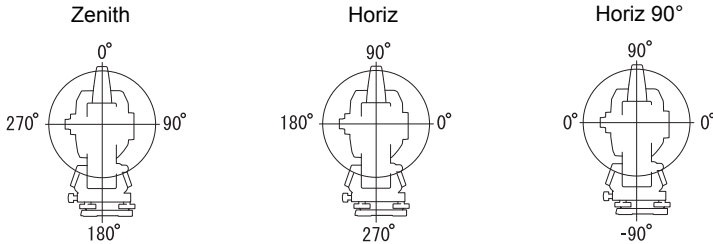

Sea level correction

The instrument calculates horizontal distance using slope distance values. As this horizontal distance does not take height above sea level into consideration, performing spherical correction is recommended when measuring at high altitudes. Spherical distance is calculated as follows.

Spherical distance

$$= \frac{R - H_a}{R} \times d_1$$

Where: R = radius of the spheroid (6372.000m)

H_a = averaged elevation of the instrument point and target point

d_1 = horizontal distance

20.2 Instrument Configuration

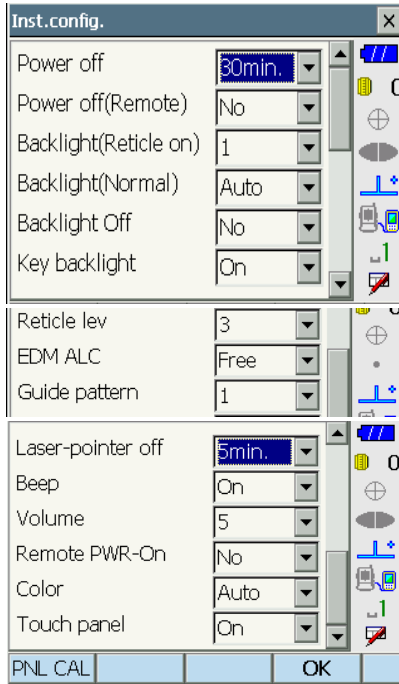

Items set and options (*: Factory setting)

Power off	: No/5min./10min./15min./30min.*
Power off (Remote)	: No*/5min./10min./15min./30min.
Backlight (Reticle On)	: 0 to 8 (1*) (Brightness level on pressing)
Backlight (Normal)	: 0 to 8 / Auto (Auto*)
Backlight Off	: No*/30sec/1min./5min./10min.
Key backlight	: Off/On*
Reticle lev	: 0 to 5 level (3*)
EDM ALC	: Free*/Hold
Guide pattern	: 1* (simultaneous)/2 (alternating)
Laser-pointer off	: No/1min./5min.* / 10min./30min.
Beep	: On*/Off
Volume	: 1 to 5 (3*)
Remote PWR-On	: Yes/No*
Color	: 1/2 (monochrome) / Auto (Auto*)
Touch panel	: On (fixed)

Note

- Press **[PNL CAL]** to display the touch panel calibration screen.
 "8.1 Configuring the Touch Panel"



Adjusting backlight brightness/turning the reticle illumination and key backlight ON/OFF

Pressing  switches the brightness level of the backlight in conjunction with the ON/OFF status of the reticle illumination/key backlight.

When the instrument is powered ON the brightness level is set to "Backlight (Normal)". "Backlight (Normal)" was set to a higher brightness level than "Backlight (Reticle ON)" when the instrument was shipped but these values can be modified according to user preferences.

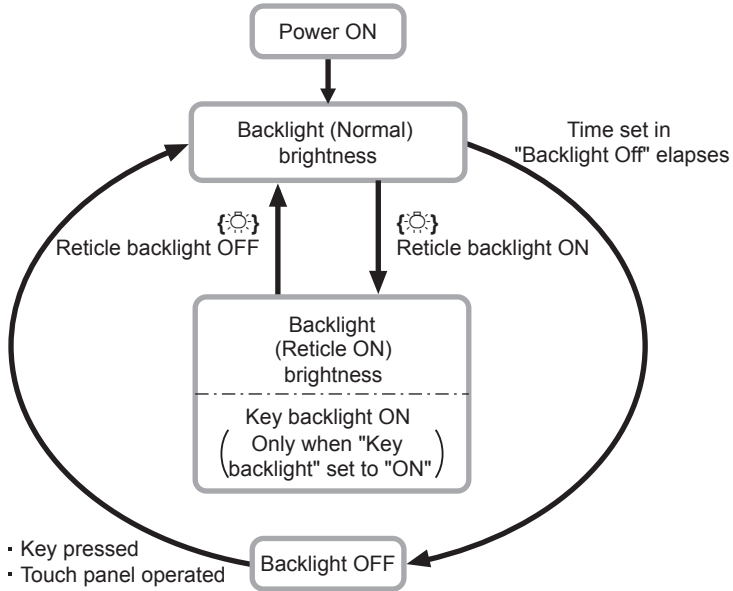

Note

- When "Backlight (Normal)" is set to "Auto" the instrument light sensor gauges the level of ambient brightness and automatically sets backlight brightness accordingly. Depending on ambient light conditions, performance of this function may be sub-optimal, or the display may flicker between brightness settings.



Power-saving automatic cut-off/Backlight Off

To save power, power to the instrument is automatically cut off if it is not operated for the set time.

The backlight will similarly be turned off if the instrument is not operated for the selected time. However, the backlight will not be turned off when "Backlight" is set to "ON".



Power-saving automatic cut-off (Power on command)

When turned on using a Power on command, power to the instrument is automatically cut off if it is not operated for the set time.

**Key backlight**

The key backlight can be set to "ON" or "OFF". When "ON" the keys will be illuminated when "Backlight (Bright)" is active.

**EDM ALC**

Set the light receiving status of the EDM. While carrying out continuous measurement, set this item according to the measurement conditions.

- When EDM ALC is set to "Free," the instrument's ALC will be automatically adjusted if an error occurs as a result of the amount of light received. Set to "Free" when the target is moved during measurement or different targets are used.
- When "Hold" is set, the amount of light received will not be adjusted until continuous measurement is completed.
- If an obstacle intermittently obstructs the light beam during continuous measurement and the "Signal off" error occurs, each time the obstruction occurs it takes some time for the amount of light received to be adjusted and the measurement value displayed. Set to "Hold" when the light beam used for measurement is stable but is frequently obstructed by obstacles such as people, cars, or tree branches etc. preventing measurement from being performed.



- When the distance measurement mode is set to "Tracking" (target is moved during distance measurement) the EDM ALC will be adjusted regardless of the EDM ALC setting.

**Laser-pointer off**

To save power, the laser-pointer is automatically turned off after the set time has elapsed.

**Color setting**

Set "Color" to "2" (monochrome) when strong sunlight reduces visibility of the display. When "Auto" is selected, the instrument detects the ambient brightness level and automatically sets the appropriate color setting accordingly.  "5.2 Display Functions"



- Do not block the instrument light sensor when "Color" is set to "Auto". The instrument will be unable to gauge ambient brightness and the display will flicker as a result.

20.3 EDM Settings

- "EDM" tab

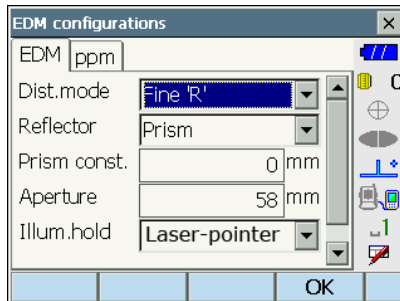

Items set, options, and input range (*: Factory setting)

Dist. mode (Distance measurement mode):	Fine "R"* , Fine AVG n= 1(Setting: 1 to 9 times), Fine "S", Rapid "R", Rapid "S", Tracking
Reflector	: Prism*/360° Prism/Sheet/N-Prism
Prism constant value	: -99 to 99 mm ("Prism" is selected: 0*, "360° Prism" is selected: -7, "Sheet" is selected: 0)
Aperture	: 1 to 999mm ("Prism" is selected: 58*, "360° Prism" is selected: 34, "Sheet" is selected: 50)
Illum. hold (☞☞) function)	: Laser-pointer*/Guide light
Guide light (Bright)	: 1 to 3 (3*)

- The setting for "Fine AVG" distance measurement mode can be increased/decreased using the [+]/[-] softkeys.
- Target information can be edited and recorded.
☞ "PROCEDURE Recording and editing target information"
- "Prism const." and "Aperture" will not be displayed when "N-Prism" is selected in "Reflector".
- When "prism const." (prism constant values) are changed and [OK] is pressed, these changes are reflected in the status bar/Starkey mode target type display temporarily. This display will also change to reflect changes in target information settings made using a data collector temporarily. In both of the above cases, changes will not be recorded in <Reflector setting>.
☞ Status bar: "5.2 Display Functions", Starkey mode: "5.4 Starkey Mode", <Reflector setting>: "PROCEDURE Recording and editing target information", Cold boot: "8.2 Resolving Software Issues ☑ Cold boot"
- The Guide light brightness item ("Guide light (Bright)") will be displayed only when "Illum. hold" is set to "Guide light".



prism constant correction value

Reflective prisms each have their prism constant.

Set the prism constant correction value of the reflective prism you are using. When selecting "N-Prism" in "Reflector", prism constant correction value is set to "0" automatically.

● "ppm" tab

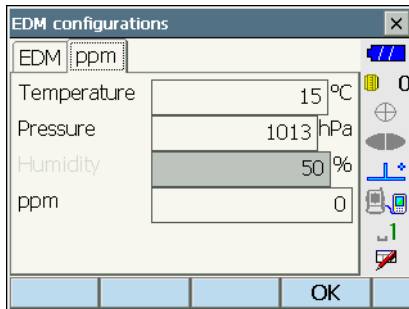

- [0ppm]: Atmospheric correction factor returns to 0 and temperature and air pressure are set to the factory settings.
- Atmospheric correction factor is calculated and set using the entered values of the temperature and air pressure. Atmospheric correction factor can also be entered directly.

- When the settings here are different between basic mode and program mode, program mode settings are prior for use.

Items set, options, and input range (*: Factory setting)

Temperature	: -30 to 60°C (15*), -22 to +140°F (59*)
Pressure	: 500 to 1400hPa (1013*), 375 to 1050mmHg (760*), 14.8 to 41.3 (inchHg) (29.9*)
Humidity	: 0 to 100% (50*)
ppm (Atmospheric correction factor)	: -499 to 499 (0*)

- The "Humidity" item is displayed only when the "ppm setting" in "Obs. condition" is set to "+Humidity".



Atmospheric correction factor

The velocity of the light beam used for measurement varies according atmospheric conditions such as temperature and air pressure. Set the atmospheric correction factor when you wish to take this influence into account when measuring.

- The instrument is designed so that the correction factor is 0 ppm at an air pressure of 1013 hPa, a temperature of 15°C, and a humidity of 50%.
- By inputting the temperature, air pressure values and humidity, the atmospheric correction value is calculated using the following formula and set into the memory.

Atmospheric Correction Factor (ppm) =

$$282.324 - \frac{0.294362 \times p}{1 + 0.003661 \times t} + \frac{0.04127 \times e}{1 + 0.003661 \times t}$$

t: Air temperature (°C)

p: Pressure (hPa)

e: Water vapor pressure (hPa)

h: Relative humidity (%)

E : Saturated water vapor pressure

- e (water vapor pressure) can be calculated using the following formula.

$$e = h \times \frac{E}{100} \frac{(7.5 \times t)}{(t + 237.3)}$$

$$E = 6.11 \times 10^{\frac{7.5 \times t}{t + 237.3}}$$

- The instrument measures the distance with a beam of light, but the velocity of this light varies according to the index of refraction of light in the atmosphere. This index of refraction varies according to the temperature and pressure. Near normal temperature and pressure conditions:

With constant pressure, a temperature change of 1°C: an index change of 1 ppm.

With constant temperature, a pressure change of 3.6 hPa: an index change of 1 ppm.

To perform high accuracy measurements, it is necessary to find the atmospheric correction factor from even more accurate temperature and pressure measurements and perform an atmospheric correction.

It is recommended that extremely precise instruments be used to monitor the air temperature and pressure.

- Enter the average temperature, air pressure and humidity along the measurement beam route in "Temperature", "Pressure" and "Humidity".

Flat terrain: Use the temperature, pressure and humidity at the midpoint of the line.

Mountainous terrain: Use the temperature, pressure and humidity at the intermediate point (C).

If it is not possible to measure the temperature, pressure and humidity at the midpoint, take such measurements at the instrument station (A) and the target station (B), then calculate the average value.

- Average air temperature : $(t_1 + t_2)/2$
- Average air pressure : $(p_1 + p_2)/2$
- Average humidity : $(h_1 + h_2)/2$

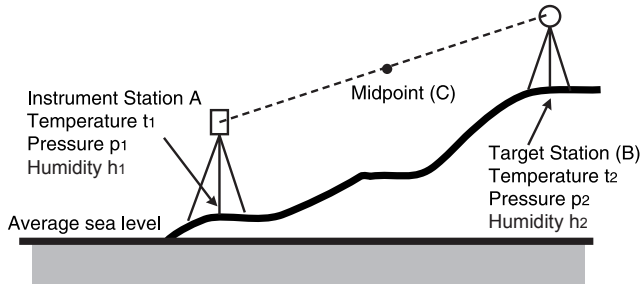

- If the weather correction is not required, set the ppm value to 0.

PROCEDURE Recording and editing target information

The [LIST] softkey is displayed when either "Reflector" or "Prism const." is selected in the "EDM" tab of <EDM configurations>.

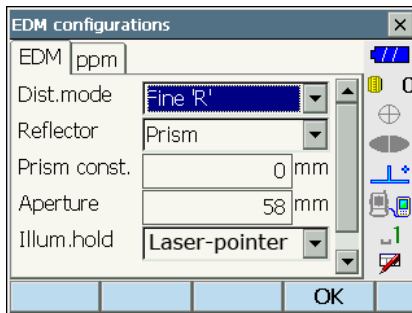

1. Press **[LIST]** to display a list of all recorded targets.
 - **[ADD]**: Displays <Reflector list>. Select the desired target from this list and press **[OK]** to register in the list in <Reflector setting>. Up to a maximum of 6 targets can be recorded.
 - **[DEL]**: Deletes the selected target.

2. To edit a target, select the desired target and press **[EDIT]**. <Reflector/edit> is displayed. Select/input relevant information for the target.

Reflector : Prism/Sheet/N-Prism/360° Prism
 Const. : -99 to 99 mm
 Aperture : 1 to 999 mm

- When selecting "N-Prism" in "Reflector", prism constant correction values and aperture are set to "0" automatically.

Reflector	Const.	Ape...
Prism	0	58
360°Prism	-7	34
Sheet	0	50
N-Prism		

3. Press **[OK]** in the screen of step 2 to save edited information and return to <Reflector setting>. Press **[OK]** to return to <EDM configurations>.

20.4 Allocating User-defined Tabs

It is possible to allocate tabs in Observation mode and Menu mode to suit the measurement conditions. It is possible to operate the instrument efficiently because unique tab allocations can be preset to suit various applications and the ways that different operators handle the instrument.

- The current tab allocations are retained until they are revised again, even when the power is cut off.
- Press **[CLEAR]** in <Customize/Select screen> to return all customized configurations including screen controls, status bar settings, and softkey allocations to their previous settings.
- One screen can contain a maximum of 5 tabs.



- When tab allocations are recorded and registered, the previously recorded tab settings are cleared.

● Tab allocations

The following are tabs allocated when the instrument was shipped and tabs that can be defined by the user.

- "Basic observation"

Factory settings	User-definable tabs
SHV	SHV
SHVdist	SHVdist
Graphic	SHV + Coord.

- Setting out

Factory settings	User-definable tabs
Obs.	Obs.
Graphic	

- Setting out Coord.

Factory settings	User-definable tabs
SHV	SHV
NEZ	NEZ
Graph1	
Graph2	



- Graphic tab cannot be deleted.

PROCEDURE Allocating tabs

1. Select "Customize" to display <Customize/Select screen>. Select the measurement mode in which you want to allocate a tab.

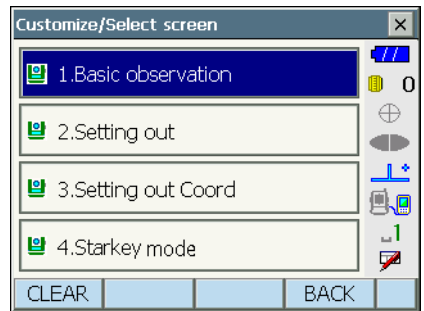

Select "Tab page".

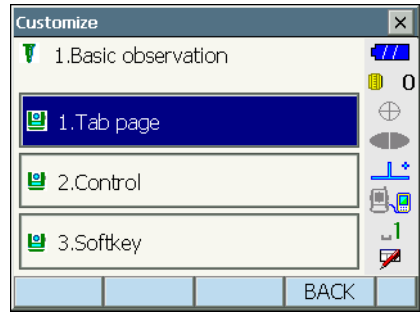

2. Use the softkeys (**[ADD]**, **[DEL]** etc.) in <Customize tab page> to allocate the desired tab page layout.

- Press **[ADD]** to add the selected tab at the right-hand side of the screen.
- Press **[INS]** in the second page to insert the selected tab in front of the current tab.
- Press **[CNFG]** in the second page to replace the current tab with the selected tab.
- Press **[DEL]** to delete the current tab.

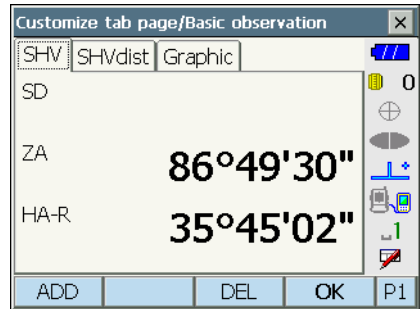

- Tabs, once deleted, cannot be retrieved.

Select a tab type from the "Type" drop-down list.

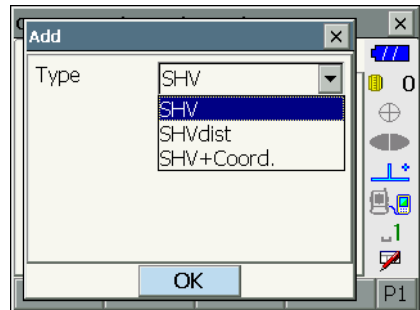

3. Repeat step 2 to perform further tab allocations.
4. Press **[OK]** to finish allocating tabs. The allocated tabs are stored in memory and <Customize> is displayed. The newly allocated tabs appear in the relevant measurement screen.

20.5 Customizing Screen Controls

It is possible to customize screen controls in Observation mode to suit the measurement conditions and the different methods employed by different operators.

- The current screen control settings are retained until they are revised again, even when the power is cut off.
- Press **[CLEAR]** in <Customize/Select screen> to return all customized configurations including tab pages, status bar settings, and softkey allocations to their previous settings.
- Screen controls cannot be set for the "Graphic" tab.



- When screen control settings are recorded and registered, the previously recorded settings are cleared.

PROCEDURE Customizing screen controls

1. Select "Customize" to display <Customize/Select screen>.
Select the measurement mode in which you want to customize screen controls.

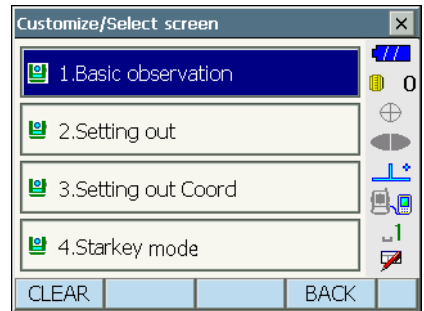

Select "Control".

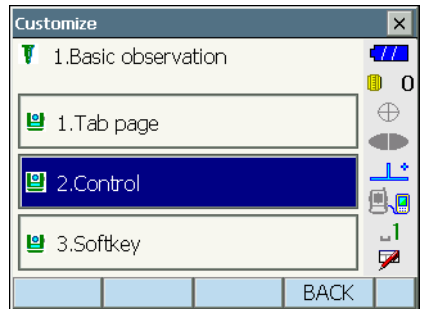

2. Press **[ADD]** to add a control drop-down list.
 - Press **[DEL]** to delete the selected control.



- Controls, once deleted, cannot be retrieved.

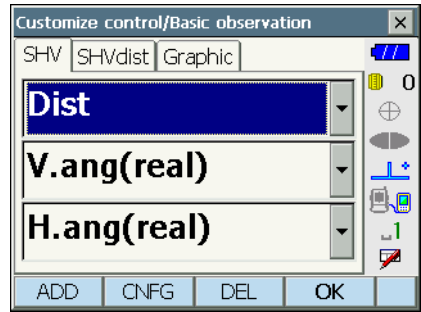

3. Select a screen control from the list.

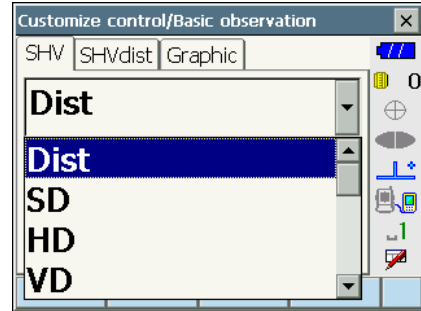

4. Press **[CNFG]** to set the size, thickness, color and spacing of the font.

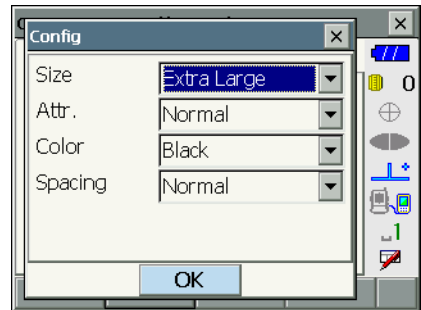

5. Repeat steps 2 to 4 to customize more screen controls.
6. Press **[OK]** to finish customizing screen controls. The modifications are stored in memory and <Customize> is displayed. The modifications are reflected in the relevant screens.

20.6 Allocating Key Functions

It is possible to allocate the softkeys in Observation mode to suit the measurement conditions. It is possible to operate the instrument efficiently because unique softkey allocations can be preset to suit various applications and the ways that different operators handle the instrument.

- The current softkey allocations are retained until they are revised again, even when the instrument is powered OFF.
- Press **[CLEAR]** in <Customize/Select screen> to return all customized configurations including tab pages, status bar settings, and screen controls to their previous settings.



- When softkey allocations are recorded and registered, the previously recorded key settings are cleared.
- Softkeys cannot be allocated to "Graphic" tabs.

● Screens that can be customized and softkey allocations when shipped

1. "SHV" and "SHVdist" tabs of <Basic observation>

Page 1 **[TRK On]** **[MOTOR]** **[0SET]** **[MEAS]**

Page 2 **[SRCH]** **[EDM]** **[H-SET]** **[COORD]**

Page 3 **[OFFSET]** **[RESEC]** **[REM]** **[S-O]**

2. "Obs." tab of <Setting out>

Page 1 **[TRK On]** **[SHVR]** **[H.TURN]** **[MEAS]**

Page 2 **[CNFG]** **[---]** **[---]** **[REM]**

Page 3 **[---]** **[---]** **[---]** **[---]**

3. "SHV" and "NEZ" tabs of <Set out Coords>

Page 1 **[OK]** **[TRK On]** **[H.TURN]** **[MEAS]**

Page 2 **[CNFG]** **[---]** **[---]** **[---]**

Page 3 **[---]** **[---]** **[---]** **[---]**

● Functions that can be allocated to the softkeys

[---]	: No functions set
[MEAS]	: Distance and angle measurement
[0SET]	: Set horizontal angle to 0°
[H-SET]	: Set required horizontal angle
[SHV]	: Switch the "SHV" tab and "SHVdist" tab (can only be allocated to 1 above)
[R/L]	: Select horizontal angle right/left. The capitalized letter in the softkey indicates the currently selected mode.
[ZA / %]	: Switch between zenith angle/slope in %. The capitalized letter in the softkey indicates the currently selected mode.
[HOLD]	: Hold horizontal angle/release horizontal angle
[CALL]	: Display final measurement data
[HVOUT-S]	: Output angle measurement results to an external device
[HVDOUT-S]	: Output distance and angle measurement results to an external device

- [HVOUT-T]** : Output angle measurement results to an external device (can only be allocated to 1 above)
- [HVDOUT-T]** : Output distance and angle measurement results to an external device (can only be allocated to 1 above)
- [NEZOUT-T]** : Output coordinates data to an external device (can only be allocated to 1 above)
- [F/M]** : Switch distance units between meters/feet
- [HT]** : Set the instrument station, coordinates and instrument height
- [S-LEV]** : Return signal
- [TILT]** : Display tilt angle
- [MOTOR]** : Display <Motor>
- [INV]** : Rotates the instrument 180°
- [SRCH]** : Automatically sights the center of the target
- [RC]** : Rotate in the direction specified by the Remote Control System
- [<-RC]** : Rotate in a counterclockwise direction (from the point of view of the RC-Controller)
- [RC->]** : Rotate in a clockwise direction (from the point of view of the RC-Controller)
- [RC Cont]** : Nullify the current measurement position and continue Turning operation
- [Fix Vel]** : Fixed velocity rotation around vertical and horizontal axes
- [TRK On]** : Start Auto Tracking (Auto Tracking model only. **[TRK Off]** during Auto Tracking)
- [EDM]** : EDM settings
- [MENU]** : Display <Menu> (coordinate measurement, setting out measurement, offset measurement, REM measurement, missing line measurement, resection, area calculation)
- [COORD]** : Coordinates measurement
- [S-O]** : Setting-out measurement
- [OFFSET]** : Offset measurement
- [A-OFS]** : Angle offset menu
- [D-OFS]** : Distance offset menu
- [2D-OFS]** : Offset/2D menu
- [MLM]** : Missing line measurement
- [REM]** : REM measurement
- [RESEC]** : Resection measurement
- [AREA]** : Surface area measurement
- [CNFG]** : Set setting out accuracy (can only be allocated to 2 and 3 above)
- [H.TURN]** : Rotate the instrument to the entered horizontal angle. Rotate horizontally to the angle for the setting out point when performing setting out (can only be allocated to 2 and 3 above).
- [SHVR]** : Switch distance mode between slope distance (SD)/horizontal distance (HD)/height difference (VD)/REM (R) in setting out screens. The capitalized letter in the softkey indicates the currently selected mode (can only be allocated to 2 above).
- [OK]** : Terminate setting out measurement for the selected setting out point and return to <Key in coord>. This setting out point will be removed from the list (can only be allocated to 3 above).

PROCEDURE Allocating a softkey

1. Select "Customize" to display <Customize/Select screen>. Select the measurement mode in which you want to allocate a softkey.

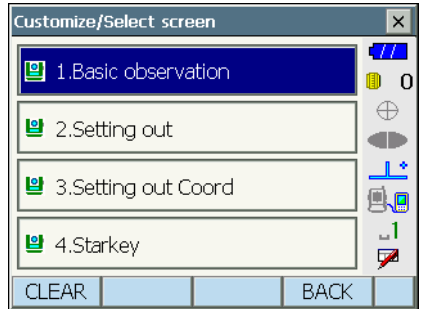

Select "Softkey".

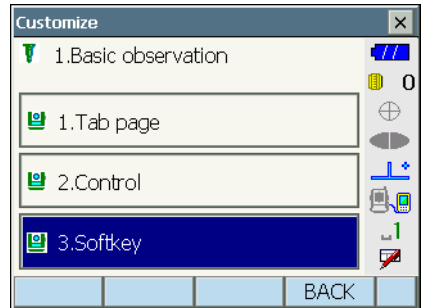

2. Select the desired tab. All softkeys currently allocated to each page of that tab are displayed.

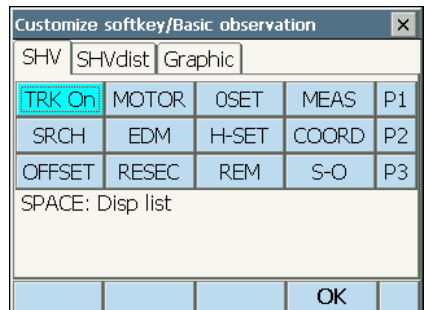

3. Select the softkey whose allocation you want to change. Tapping a softkey, or pressing **{SPACE}** when the cursor is aligned with a softkey, will display <Softkey list>.

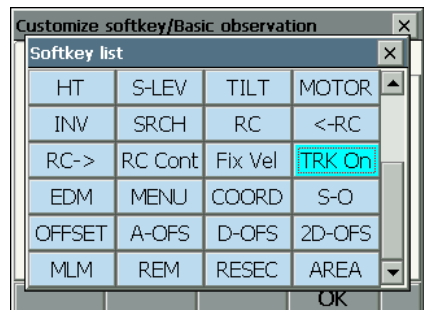

4. Select the desired softkey from <Softkey list> to allocate to the position specified in step 3.
5. Repeat steps 3 to 4 to perform further key allocations.
6. Press **[OK]** to finish allocating keys. The allocated keys are stored in memory and <Customize> is displayed. The newly allocated keys appear in the relevant measurement screen.

20.7 Changing Starkey Mode Icons

It is possible to preset icon allocations of the Starkey mode to suit various applications and the ways that different operators handle the instrument.

- The current icon allocations are retained until they are revised again, even when the power is turned off.
- Press **[CLEAR]** in <Customize/Select screen> to return all customized configurations including tab pages, screen controls and softkey allocations to their previous settings.



- When icon allocations are recorded and registered, the previously recorded settings are cleared.
- When icon allocations are recorded and registered, the setting reflects to Status bar.

● Icons that can be allocated to the status bar

Remaining battery power
 Target display
 Motor
 Laser-pointer/guide light
 Tilt angle compensation
 Communication status
 Input mode
 SIP (Input panel)
 ppm (atmospheric correction factor)
 Touch panel
 Disk
 No icon

PROCEDURE Changing icon allocations

1. Select "Customize" to display <Customize/Select screen>.

Select "Starkey".

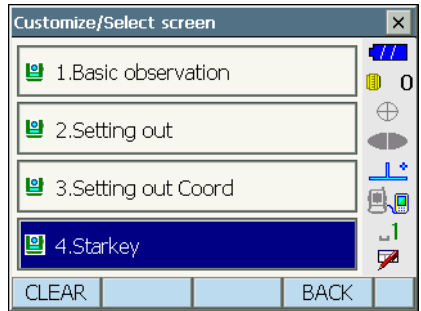

2. Select the icon (in the Starkey mode) you wish to re-allocate. Tap the icon to display <Starkey list>.

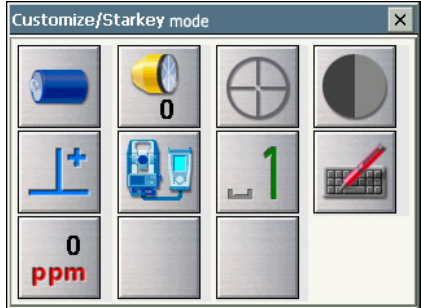

3. Select the new icon from <Starkey list>. The icon is allocated in the selected icon position.

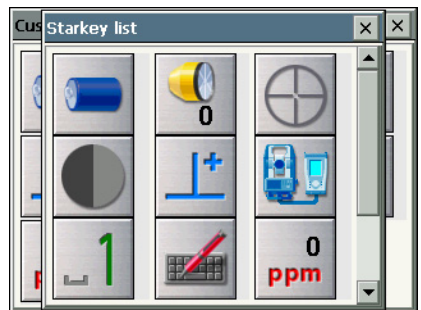

4. Repeat steps 2 to 3 to perform further icon allocations.
5. Press **{ENT}** to finish allocating icons. The allocated icons are stored in memory and <Customize/Select screen> is restored. The newly allocated icons appear in the Starkey mode.

20.8 Units

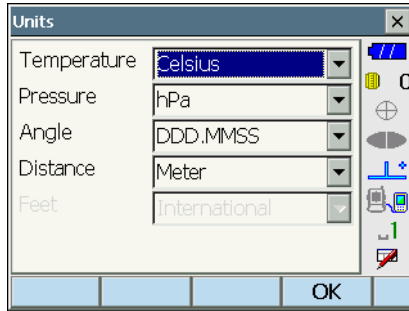

Items set and options (*: Factory setting)

Temperature	: Celsius*/Fahrenheit
Pressure	: hPa*/mmHg/InchHg
Angle	: Degree (DDD.MMSS)*°/Gon/Mil
Distance	: Meter*/Feet/Inch
Feet (only displayed when "Feet" or "Inch" selected above):	International*/US



- OS rounds off the value input by the digit of less than 0.004 feet/0.017 inch.



Inch (Fraction of an inch)

"Fraction of an inch" is the unit used in the United States and expressed like the following example.

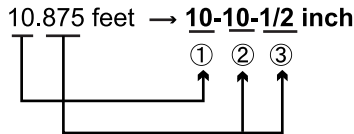

- ① 10.000 feet
- ② 0.875 feet x 12=10.5 inch
- ③ 0.5 inch=1/2 inch



- Even if "inch" is selected in this setting, all the data including the result of area calculation are output in "feet" and all the distance values must be input in "feet". In addition, when the "inch" display exceeds the range, it is displayed in "feet".

20.9 Changing Password

Setting a password allows you to protect important information such as measurement data.

No password was set when the instrument was shipped. When setting a password for the first time, leave the "Old password" box blank.

When a password has been set, the password screen will appear when the instrument is powered ON. Input the password to continue.

- Password can be up to 16 characters in length. Input characters will be displayed as asterisks.
- To deactivate the password function, perform the new password setting procedure but enter a "space" in the "New password" box.



- The password function will not be canceled when a cold boot is performed.
- The password must be input after powering ON the instrument from an external device when a password has been set.

Items set

- | | |
|--------------------|--------------------------------|
| Old password | : Input current password |
| New password | : Input the new password |
| New password again | : Input the new password again |

20.10 Date and Time

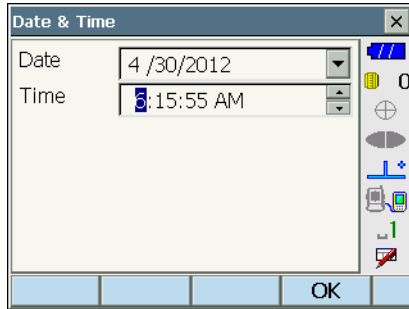

Items set

- Date : Manually input date or select from the drop-down calendar by tapping ▼.
- Time : Manually input time or set using [▲]/[▼].
Pressing {SPACE} will increment the selected section by 1.



Date and Time

The instrument includes a clock/calendar function.

20.11 Restoring Default Settings

Perform a cold boot to return all items to factory settings. A cold boot will not erase surveying data in instrument. However, if the data in the memory is important, BE SURE TO TRANSFER IT TO A PERSONAL COMPUTER BEFORE PERFORMING A COLD BOOT.



- The password function will not be canceled.
- Resume function will be canceled.

PROCEDURE

1. "To perform a cold boot, while holding {☼} and {S.P.}, press the power key on the side of the instrument.
"All Settings will be cleared. Are you sure?" is displayed.
2. Press [YES] to continue.
 - Select [NO] and press {ENT}, or press {ESC} to cancel.
3. When the power is ON after the a cold boot, the screen for configuring the touch panel is displayed. Configure the touch panel to continue.
☞ "8.1 Configuring the Touch Panel"

21. WARNING AND ERROR MESSAGES

The following is a list of the error messages displayed by the instrument and the meaning of each message. If the same error message is repeated or if any message not shown below appears, the instrument has malfunctioned. Contact your local dealer.

Backup battery dead. Clock display may no longer be correct.

The voltage supplied by the lithium battery either declines or is completely discharged. Ask your local dealer to replace the battery for you.

Bad condition

The air is shimmering a lot, etc., measuring conditions are poor.

The center of the target cannot be sighted.
Resight the target.

Unsuitable distance measurement conditions when reflectorless measurement is set. When reflectorless measurement is set, distance cannot be measured because the laser beam is striking at least two surfaces at the same time.

Choose a single surface target for distance measurement.

 Precautions for setting prism: "10. TARGET SIGHTING"

Calculation error

During resection measurement the same point is registered multiple times. Set another known point so that the known point coordinates do not coincide.

Coordinates identical to the known point coordinates observed during resection exist.

During surface area calculation, conditions necessary for calculations are not met. Check conditions and try again.

An error occurred during calculation.

Device list is full !!

No more *Bluetooth* devices can currently be registered. Delete unnecessary devices from the list and try again.

Disconnect *Bluetooth*

Wireless connection disconnected. Re-connect and try again.

Error: Read Build Info.

Error: Read sysflg

Error: Self check

Error: Read OS Parameter

Error: Write sysflg

Press **[OK]** to cancel the message. If this error message appears frequently, contact your local dealer.

Incorrect password.

Input password does not match set password. Input correct password.

Input device name !!

Bluetooth device name not input. Input device name and complete device registration.

Input over 3 letters !

The input password consists of less than 3 characters. Input a password at least 3 characters in length.

Motor error EXXX

A problem has occurred with the motor drive and operation stops.
Power the instrument OFF then ON to correct the problem.
If this error message appears frequently, contact your local dealer.

Need base pt. obs

During REM measurement, the observation of the target was not completed normally.
Reset and sight the prism and perform measurement again.

Need 1st obs

During missing line measurement, the observation of the starting position was not completed normally.
Sight the starting position accurately and press **[MEAS]** to perform the measurement again.

New password Diff.

During new password setting, the passwords input twice are different. Input new password twice correctly.

No solution

The calculation of the instrument station coordinates during resection does not converge.
Access the results and if necessary, perform the observations again.

Out of range

During gradient % display, the display range (less than $\pm 1000\%$) has been exceeded.
During REM measurement, either the vertical angle has exceeded horizontal $\pm 89^\circ$ or the measured distance is greater than 9999.999m.
Install the instrument station far from the target.

Please input an address consisting of 12 hexadecimal characters (0 to 9, A to F)

The *Bluetooth* address is not input correctly for *Bluetooth* communication. Input the *Bluetooth* address with 12 characters of 0 to 9 or A to F.

Reflectorless not supported !!

Auto Tracking cannot be performed in reflectorless mode.
Use the prism to carry out automatic sighting.

Remote Control communication err !!

Communication between the Remote controller for Remote Control System and the instrument failed. Check the status (communications setup, power supply, cable connections etc.) of the Remote controller, wireless modem and cables.

Sheet not supported !!

Auto Tracking cannot be performed with the sheet.
Use the prism to carry out automatic sighting.

Signal off

The reflected light is not observed when distance measurement begins. Or, during measurement, the reflected light has weakened or is blocked.

Either sight the target again or, when using a reflective prism, increase the number of reflective prisms.

Target not found !!

The prism cannot be found within the Search area range.

Reset and sight the prism and perform measurement again.

Temp Rnge OUT

The instrument is outside useable temperature range and accurate measurement cannot be performed. Repeat measurement within the appropriate temperature range.

Tilt over range !!

The tilt angle exceeds the tilt angle compensation range of the sensor.

Level the instrument again.

Time out !!

Measurement is not carried out in the allotted time.

Reset and sight the prism and perform measurement again.

When designating the angle of rotation or automatically sighting the prism, there is a problem with the positioning of the prism or the operation of the instrument and measurement is not obtained within the fixed time.

Check the positioning of the instrument and prism and perform measurement again.

If observation is still not possible, sight the target manually.

22.CHECKS AND ADJUSTMENTS

PS is a precision instrument that requires fine adjustments. It must be inspected and adjusted before use so that it always performs accurate measurements.

- Always perform checking and adjustment in the proper sequence beginning from "22.1 Circular Level" to "22.7 Additive Distance Constant".
- In addition, the instrument should be inspected with special care after it has been stored a long time, transported, or when it may have been damaged by a strong shock.
- Make sure the instrument is securely set up and stable before performing checks and adjustments.

22.1 Circular Level

The bubble tube is made of glass, so it is sensitive to temperature changes or to shock. Check and adjust it as outlined below.



- Be careful that the tightening tension is identical for all the adjusting screws. Also, do not over-tighten the adjusting screws as this may damage the circular level.

PROCEDURE Checking and adjusting

1. Level while checking the display.

 "7.2 Levelling"

Note

- Tap Tilt angle compensation icon  in the status bar or in Starkey mode to display electric circular level.



- If the tilt sensor is misaligned, the circular level is not adjusted correctly.

 "22.2 Tilt Sensor"

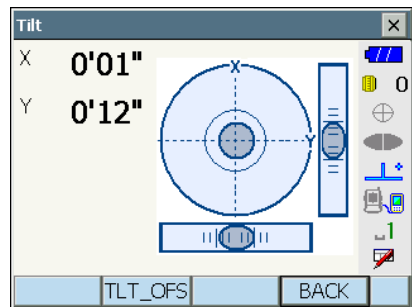

2. Check the position of the bubble of the circular level.

If the bubble is not off-center, no adjustment is necessary.

If the bubble is off-center, perform the following adjustment.

3. First confirm the off-center direction. Use the adjusting pin to loosen the circular level adjustment screw on the side opposite to the direction the bubble is displaced to move the bubble to the center.
4. Adjust the adjusting screws until the tightening tension of the three screws is the same to align the bubble in the middle of the circle.

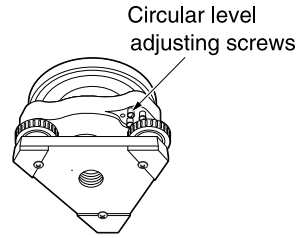

22.2 Tilt Sensor

If the tilt angle shown on the display shifts from tilt angle 0° (zero point), the instrument is not correctly levelled. This will adversely affect angle measurement. Perform the following procedure to cancel the tilt zero point error.

PROCEDURE Checking and adjusting

1. Carefully level the instrument. If necessary, repeat the procedures to check and adjust the bubble levels.
2. Select "Inst. cons." in <Configuration>

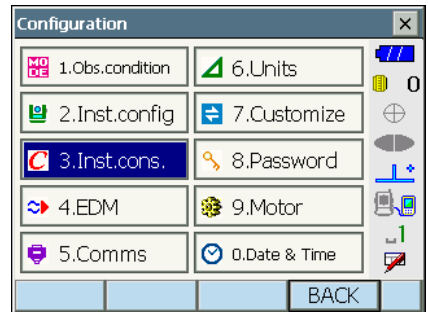

3. Select "Tilt offset".

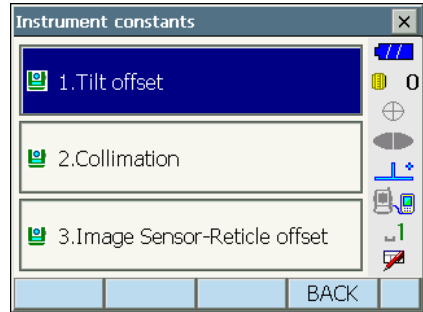

4. Level the instrument until the X/Y tilt angles are $\pm 1'$. Wait a few seconds for the display to stabilize, then read the current tilt angle in the X (sighting) direction and Y (horizontal axis) direction.

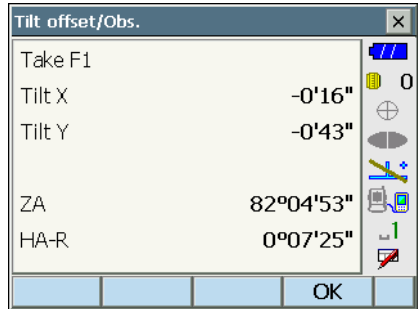

5. Press **[OK]**. The top of the instrument and telescope rotate 180° from the current position.
6. Wait a few seconds for the screen to stabilize, then read the automatically compensated angles X2 and Y2.
7. In this state, calculate the following offset values (tilt zero point error).
 $X_{\text{offset}} = (X1+X2)/2$
 $Y_{\text{offset}} = (Y1+Y2)/2$

If one of the offset values (X_{offset} , Y_{offset}) exceeds $\pm 10''$, adjust the value using the following procedure.
 When the offset value falls within the range $\pm 10''$, adjustment is not necessary.
 Press **[ESC]** to return to <Instrument constants>.

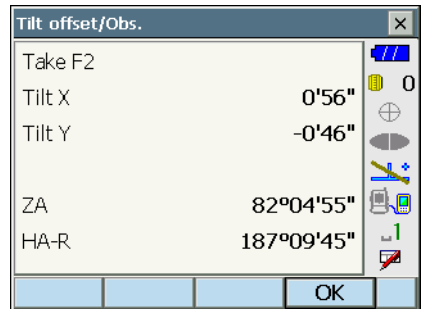

8. Press **[OK]** to automatically rotate the top of the instrument and telescope through 180°.

9. Confirm that the values are in the adjustment range.

If both correction constants are within the range the current value $\pm 1'$, select **[YES]** to renew the correction angle. <Instrument constants> is restored. Continue to step 11. If the values exceed the adjustment range, select **[NO]** to cancel the adjustment and return to the screen in step 4. Contact your local dealer to perform the adjustment.

Results for target point

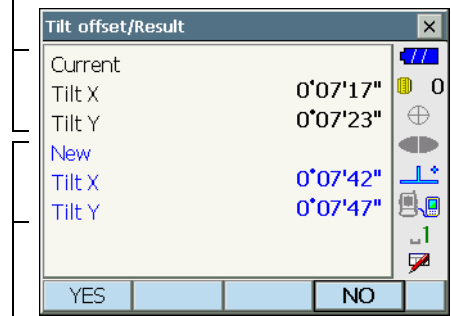

Results for offset point

PROCEDURE Recheck

10. Select "Tilt offset".
11. Wait a few seconds for the display to stabilize, then read the automatically compensated angles X3 and Y3.
12. Press **[OK]** to automatically rotate the top of the instrument and telescope through 180°.
13. Wait a few seconds for the display to stabilize, then read the automatically compensated angles X4 and Y4.
14. In this state, the following offset values (tilt zero point error) are calculated.
 $X_{\text{offset}} = (X3+X4)/2$
 $Y_{\text{offset}} = (Y3+Y4)/2$
 When both offset values fall within the range $\pm 10''$, adjustment is completed.
 Press **{ESC}** to return to <Instrument constants>.

If one of the offset values (X_{offset} , Y_{offset}) exceeds $\pm 10''$, repeat the check and adjustment procedures from the beginning. If the difference continues to exceed $\pm 10''$ after repeating the check 2 or 3 times, have your local dealer perform the adjustment.

22.3 Collimation

With this option you can measure collimation error in your instrument so that the instrument can correct subsequent single face observations. To measure the error, make angular observations using both faces.

PROCEDURE

- Carefully level the instrument.
- Select "Inst. cons." in <Configuration>.

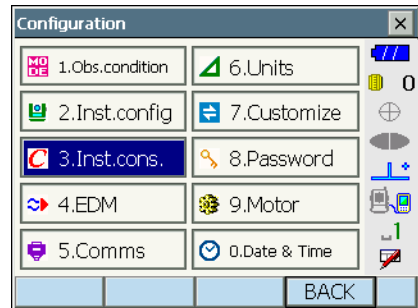

- Select "Collimation".

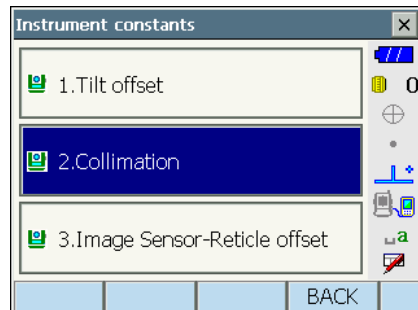

- Sight the reference point in Face 1 and press **[OK]**. Telescope rotates and vertical circle is indexed.



- Do not look through the telescope eyepiece while the motor drive is in operation. An eye could be struck by the telescope and cause injury.

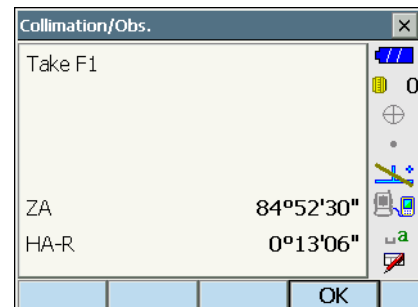

4. Sight the reference point in Face 2 and press [OK].

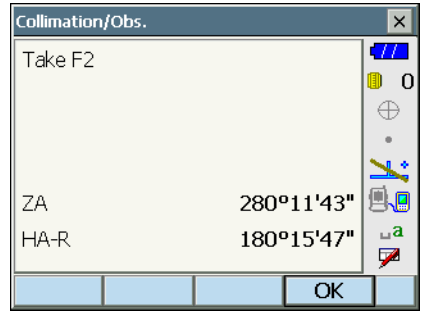

5. Press [YES] to set the constant.
- Press [NO] to discard the data and return to the screen in step 3.

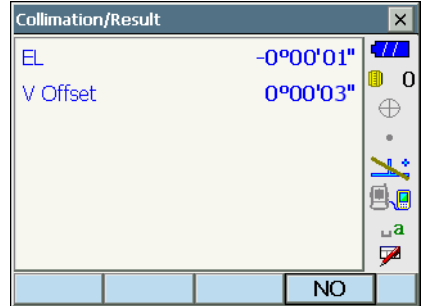

22.4 Reticle

With this option you can check the perpendicularity of the reticle and the horizontal/vertical positions of reticle lines.



- Check the telescope reticle by sighting the target.

PROCEDURE Check 1: Perpendicularity of the reticle to the horizontal axis

1. Carefully level the instrument.
2. Align a clearly visible target (the edge of a roof for example) on point A of the reticle line.

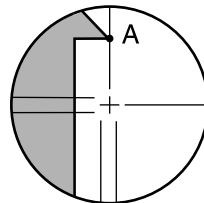

- Use the fine motion screws to align the target to point B on a vertical line.

If the target moves parallel to the vertical line, adjustment is unnecessary. If its movement deviates from the vertical line, have our service representative adjust it.

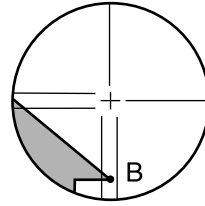

PROCEDURE Check 2: Vertical and horizontal reticle line positions

- Carefully level the instrument.
- Install a target at a point about 100m in the horizontal direction from the instrument.



- While the Observation mode screen is displayed and the telescope is in face left, sight the center of the target and read out the horizontal angle A1 and the vertical angle B1.

Example:

Horizontal angle A1 = 18° 34' 00"

Vertical angle B1 = 90° 30' 20"

- While the telescope is in face right, sight the center of the target and read out the horizontal angle A2 and the vertical angle B2.

Example:

Horizontal angle A2 = 198° 34' 20"

Vertical angle B2 = 269° 30' 00"

- Do the calculations: A2-A1 and B2+B1

If A2-A1 is within 180°±20" and B2+B1 is within 360°±20", adjustment is unnecessary.

Example: A2-A1 (Horizontal angle)

= 198° 34' 20" - 18° 34' 00"

= 180° 00' 20"

B2+B1 (Vertical angle)

= 269° 30' 00" + 90° 30' 20"

= 360° 00' 20"

If the difference is large even after repeating the check 2 or 3 times, have our service representative perform the adjustment.

22.5 Image Sensor Reticle

The internal image sensor is used for automatic sighting. The offset value is set to correct the position of the image sensor in relation to the telescope reticle, but if for whatever reason the telescope reticle and image sensor become misaligned, automatic sighting of the center of the prism cannot be performed correctly. Check and adjust it as outlined below.



- Perform check and adjustment in weak sunlight and no scintillation.
- It may take up to 20 seconds for an offset value based on the measurement results to appear.
- Use Standard prism Prism-2. Using other prism types may result in adjustment inaccuracies.

PROCEDURE Checks and adjustments

1. Carefully level the instrument.
2. Position the prism in a horizontal direction approximately 50 meters from the instrument.
3. Select "Inst.cons." in <Settings>.



3. Select "Inst.cons." in <Settings>.

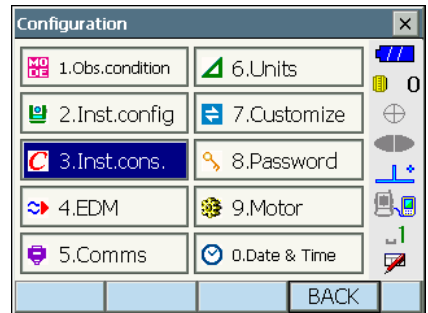

4. Select "Image Sensor-Reticle offset".

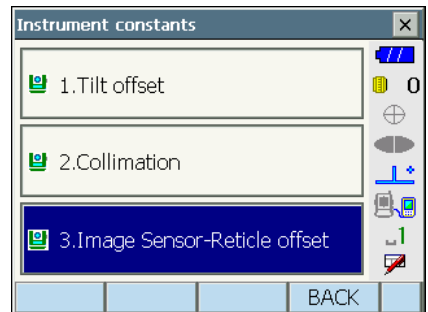

- Use manual sighting to accurately sight the target.

 "10.3 Manually Sighting the Target"

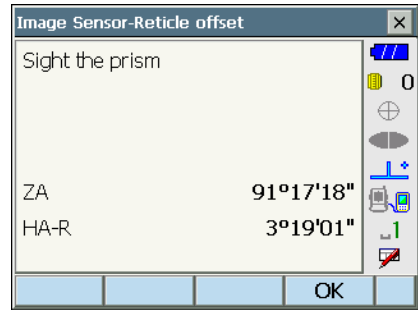

- Press **[OK]**.

- Offset value (H, V) (New) is obtained from the set offset value (H, V) (Current) and the measurement results. The offset value is a constant value that indicates the number of degrees of misalignment between the center of the telescope reticle and the center of the image sensor. If the offset value obtained from the measurement result is significantly larger than the set offset value, press **{ESC}** and resight the target.

If the offset value (H, V) obtained from the measurement results continues to be significantly large after repeated checks, adjustment is necessary. Go to step 8.

Set offset value

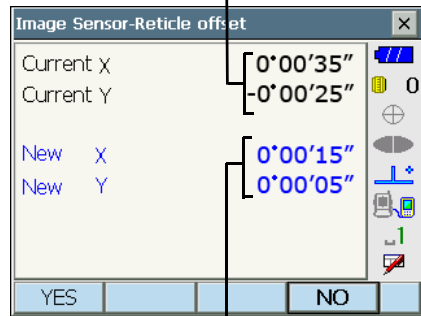

Offset value obtained from measurement

If one of the offset values exceeds the range, an error message appears on the screen. Contact your local dealer to perform the adjustment.

- Press **[OK]** to renew the offset value.

22.6 Optical Plummet



- Be careful that the tightening tension is identical for all the adjusting screws.
- Also, do not over-tighten the adjusting screws as this may damage the circular level.

PROCEDURE Checking

1. Carefully level the instrument and center a survey point precisely in the reticle of the optical plummet.
2. Turn the upper part through 180° and check the position of the survey point in the reticle.
If the surveying point is still centered, no adjustment is necessary.
If the survey point is no longer centered in the optical plummet, perform the following adjustment.

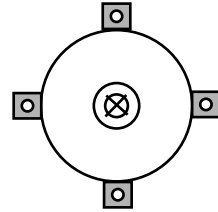

PROCEDURE Adjustment

3. Correct half the deviation with the levelling foot screw.

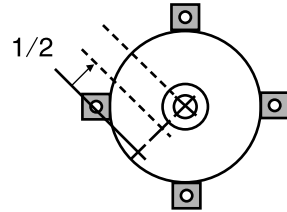

4. Remove the optical plummet reticle cover.
5. Use the 4 adjusting screws of the optical plummet to adjust the remaining half of the deviation as shown below.
When the survey point is on the lower (upper) part of the illustration:
Loosen the upper (lower) adjusting screw slightly, and tighten the upper (lower) adjusting screw the same amount to move the survey point to a point directly under the center of the optical plummet.
(It will move to the line in the figure on the right.)

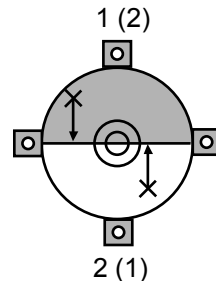

If the survey point is on the solid line (dotted line):
Loosen the right (left) adjusting screw slightly and, tighten the left (right) adjusting screw by the same amount to move the survey point to a point in the center of the optical plummet.

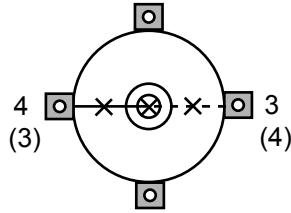

6. Check to make sure that the survey point remains centered on the reticle even if the upper part of the instrument is rotated.
If necessary, perform the adjustment again.
7. Replace the optical plummet reticle cover.

22.7 Additive Distance Constant

The additive distance constant K of the instrument is adjusted to 0 before delivery. Although it almost never deviates, use a baseline with a known distance precision to check that the additive distance constant K is close to 0 several times a year and whenever the values measured by the instrument begin to deviate by a consistent amount. Perform these checks as follows.

- Errors in setting up the instrument and reflective prism or in sighting the target will influence the additive distance constant. Be extremely careful to prevent such errors when performing these procedures.
- Set up so that the instrument height and the target height are identical. If a flat place is not available, use an automatic level to make sure the heights are identical.

PROCEDURE Check

1. Find an area of flat ground where two points 100m apart can be selected.
Set up the Instrument at point A and the reflective prism at point B. Establish a point C half way between points A and B.
2. Precisely measure the horizontal distance between point A and point B 10 times and calculate the average value.

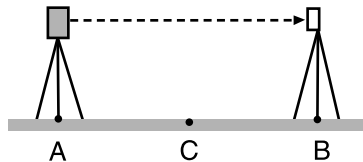

- Place the instrument at point C directly between points A and B and set up the reflective prism at point A.

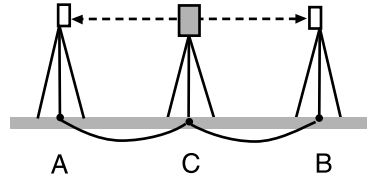

- Precisely measure the horizontal distances CA and CB 10 times each and calculate the average value for each distance.
- Calculate the additive distance constant K as follows.
$$K = AB - (CA + CB)$$
- Repeat steps 1 to 5 two or three times. If the additive distance constant K is within $\pm 3\text{mm}$ even once, adjustment is unnecessary. If it always exceeds this range, have our service representative perform an adjustment.

23. POWER SUPPLY SYSTEM

Operate your instrument with the following combinations of power equipment.



- When using an external battery, mount the BDC70 in place to maintain the balance of the instrument.
- Never use any combination other than those indicated below. If you do, the instrument could be damaged.

Those indicated by * are standard accessories. Others are optional accessories.

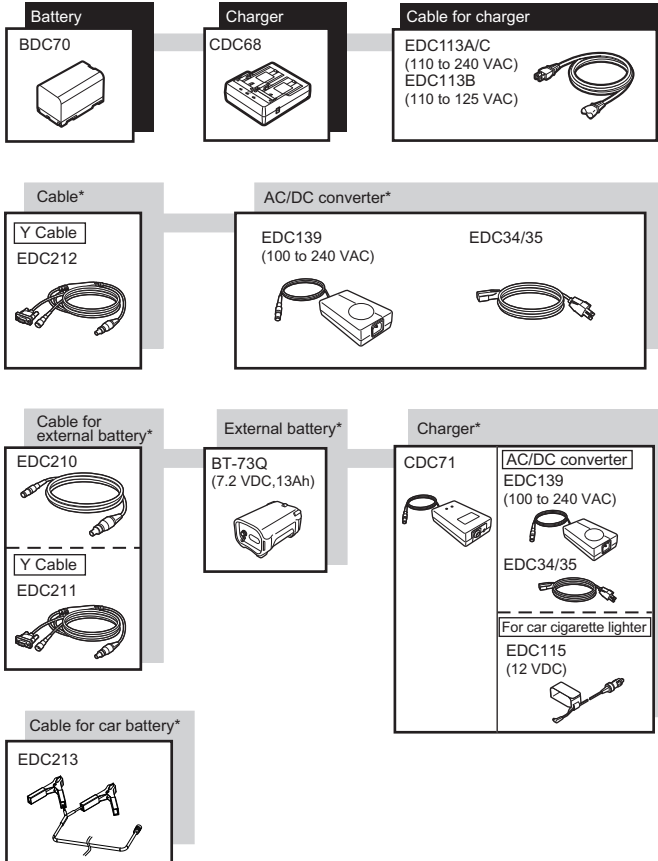

Note

- By using the Y cable the instrument can perform RS232C communication (D-sub 9-pin) at the same time as connecting to an external power source.

24.PRISM SYSTEM

Arrangement according to your needs is possible.

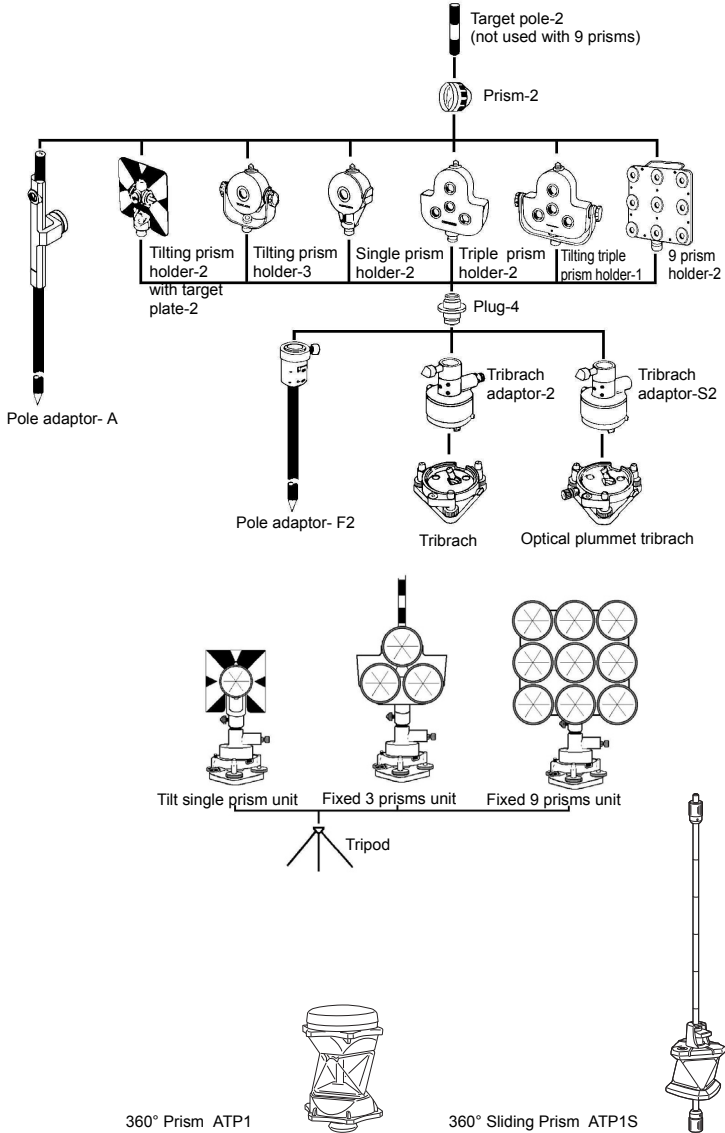

- Use the above prisms after setting them at the same height as the instruments. To adjust the height of prism set, change the position of fixing screws.
- Plug-4 is necessary for the tribrach adaptor-2, tribrach adaptor-S2 and pole adaptor-F2 to coincide with the height of this series.

25. OPTIONAL ACCESSORIES

The following are optional accessories which are sold separately from the instrument.

 Power supply and target optional accessories: "23. POWER SUPPLY SYSTEM", "24. PRISM SYSTEM".

● Plumb bob

The plumb bob can be used to set up and center the instrument on days when there is little wind. To use the plumb bob, unwind its cord, pass it through the cord grip piece as shown in the figure to adjust its length, then suspend it from the hook attached to the centering screw.

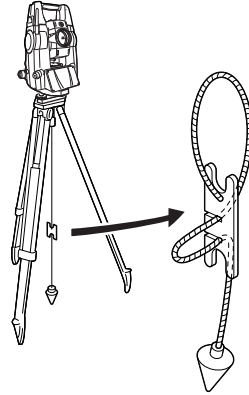

● Tubular compass (CP7)

Slide the tubular compass into the tubular compass slot, loosen the clamp screw, then rotate the top part of the instrument until the compass needle bisects the index lines. The telescope's face 1 sighting direction in this position will indicate magnetic north. After use, tighten the clamp and remove the compass from the slot.



- The tubular compass is susceptible to the influence of nearby magnets or metal. Such influence could cause it to fail to accurately indicate magnetic north. Do not use magnetic north as indicated by this compass for base line surveying.

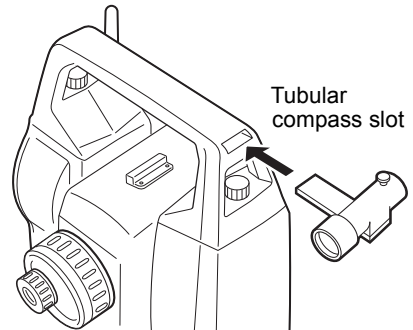

● Telescope eyepiece lens (EL7)

Magnification: 40X
Field of view: 1° 20'

● **Diagonal eyepiece (DE27)**

The diagonal eyepiece is convenient for observations near the nadir and in narrow spaces. Magnification: 30X

After removing the handle from the instrument loosen the attachment screw to remove the telescope eyepiece. Then screw the diagonal lens into place.

☞ Handle removal method: "4.1 Parts of the Instrument "Handle""

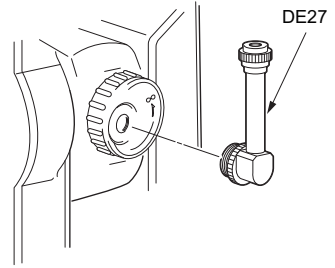

- Do not perform vertical rotation of the telescope when using the diagonal eyepiece. The diagonal eyepiece may strike the instrument causing damage.

● **Solar filter (OF3A)**

When sighting targets where glare is present, solar observations for example, attach it to the objective lens of the instrument to protect its interior and the eyes of its operator. The filter part can be flipped up without being removed.

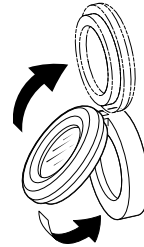

- Do not perform vertical rotation of the telescope when using the solar filter. The solar filter may strike the instrument causing damage.

● **Interface cable**

Connect the instrument to a host computer using the following cables.

Cable	Notes
DOC210	Pin number and signal level : RS232C compatible
EDC211 (Y cable)	D-Sub connector : 9 pins (female)
DOC212 (Y cable)	



- By using the Y cable the instrument can perform RS232C communication (D-Sub 9-pin) at the same time as connecting to an external power source.

● **Remote Controller (RC-5R)**

This is the remote controller for Remote Control System which points the instrument (PS) in the direction of the prism with speed and precision.

 Remote Control System Manual



- This system can be used only when Beam detector for Remote Controller is mounted on the handle of the instrument (PS).

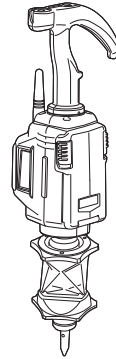

● **2-point target (2RT500-K)**

This target is used for two-distance offset measurement.

Prism constant correction value: 0

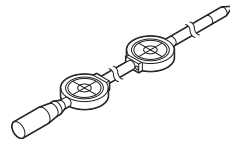

26.SPECIFICATIONS

Except where stated, the following specifications apply to all PSs.

Telescope

Length	168mm
Aperture	45mm (1.8 inch) (EDM: 48mm (1.9 inch), Tracking: 50mm (2.0 inch))
Magnification	30X
Image	Erect
Resolving power:	2.5"
Field of view	1°30' (26m/1,000m)
Minimum focus	1.3m (4.3ft)
Focussing screw	1 speed
Reticle illumination	5 brightness levels

Angle measurement

Horizontal and Vertical circles type	Rotary absolute encoder
Detecting	2 sides
Angle units	Degree/Gon/Mil (selectable)
Minimum display	PS-101A/101AC/102A/102AC: 0.5" (0.0001gon/0.002mil)/1" (0.0002gon/0.005mil) (selectable) PS-103A/103AC/105A/105AC: 1" (0.0002gon/0.005mil)/5" (0.0010gon/0.020mil) (selectable)
Accuracy	PS-101A/101AC: 1" (0.0003gon/0.005mil) PS-102A/102AC: 2" (0.0006gon/0.010mil) PS-103A/103AC: 3" (0.001gon/0.015mil) PS-105A/105AC: 5" (0.0015gon/0.025mil) (ISO 17123-3 : 2001)
Collimation compensation	On/Off (selectable)
Measuring mode	Horizontal angle: Right/Left (selectable) Vertical angle: Zenith/Horizontal/Horizontal $\pm 90^\circ$ /% (selectable)

Tilt angle compensation

Type	Liquid 2-axis tilt sensor
Correction unit	1"
Range of compensation	$\pm 6'$ (± 0.0019 gon)
Compensation accuracy	PS-101A/101AC: $\pm 3''$ PS-102A/102AC/103A/103AC/105A/105AC: $\pm 4''$
Automatic compensator	ON (V & H/V)/OFF (selectable)
Tilt offset	Can be changed

Distance measurement

Measuring method	Coaxial phase-contrast measuring system
Signal source	Red laser diode 690nm Class 3R (IEC60825-1 Ed. 2.0: 2007/FDA CDRH 21CFR Part1040.10 and 1040.11 (Complies with FDA performance standards for laser products except for deviations pursuant to Laser Notice No.50, dated July 26, 2001.)) (When the prism or reflective sheet is selected in Config mode as target, the output is equivalent to Class 1)

Measuring range ^{*9}	(Using the following reflective prism/reflective sheet target during normal atmospheric conditions ^{*1/ *2} is good atmospheric conditions)
360° Prism ATP1/ATP1S: ^{*2}	1.3 to 1,000 m (3,280ft) ^{*3}
Prism-5:	1.3 to 500m (1,640ft) ^{*7}
Prism-2 X 1:	1.3 to 5,000m (16,400ft) ^{*7} (to 6,000m) (19,680ft) ^{*7}
Prism-2 X 3:	to 8,000 m (26,240ft) ^{*7} (10,000m) (32,800ft) ^{*6}
Reflective sheet RS90N-K:	1.3 to 500m (1,640ft) ^{*4}
Reflective sheet RS50N-K:	1.3 to 300m (980ft) ^{*4}
Reflective sheet RS10N-K:	1.3 to 100m (320ft) ^{*4}
Reflectorless (White) :	0.3 to 800m (2,620ft) ^{*5} (to 1,000m) (3,280ft) ^{*6}
Prism and reflective sheet target (tracking) ^{*3,4}	:1.3 to 960m (3,140ft)
Reflectorless (White) (tracking) ^{*5}	:0.3 to 300m (980 ft)
Minimum display	
Fine measurement:	0.0001m (0.001ft/ 1/16 inch)/0.001 m (0.005ft/ 1/8 inch)
Rapid measurement:	0.001 m (0.005ft/ 1/8 inch)
Tracking measurement:	0.01 m (0.1ft/ 1/2 inch)
Maximum slope distance display	12,000.000m (39,370ft) (using prism or reflective sheet target) 1,200.000m (3,930ft) (Reflectorless)
Distance unit	m/ft/inch (selectable)
Accuracy (D: measurement distance; Unit: mm) (Under normal atmospheric conditions ^{*1, *9})	
(Using prism or using 360° Prism ATP1/ATP1S) ^{*3}	Fine measurement: $\pm(1.5 + 2 \text{ ppm X D})$ mm Rapid measurement: $\pm(5 + 2 \text{ ppm X D})$ mm
(Using reflective sheet target) ^{*4}	Fine measurement: $\pm(2 + 2 \text{ ppm X D})$ mm Rapid measurement: $\pm(5 + 2 \text{ ppm X D})$ mm
(Reflectorless (White)) ^{*5}	Fine measurement: $\pm(2 + 2\text{ppm X D})$ mm (0.3 to 200m) ^{*8} $\pm(5 + 10\text{ppm X D})$ mm (over 200 to 350m) $\pm(10 + 10\text{ppm X D})$ mm (over 350 to 10,00m) Rapid measurement: $\pm(6 + 2\text{ppm X D})$ mm (0.3 to 200m) $\pm(8 + 10\text{ppm X D})$ mm (over 200 to 350m) $\pm(15 + 10\text{ppm X D})$ mm (over 350 to 10,00m)
(ISO 17123-4 : 2001)	
Measurement mode	Fine measurement (single/repeat/average)/Rapid measurement (single/repeat)/Tracking (selectable)
Measuring time	(fastest time under good atmospheric conditions ^{*2} , no compensation, EDM ALC at appropriate setting, slope distance)
Fine measurement:	less than 1.5 sec + every 0.9 sec or less
Rapid measurement:	less than 1.3 sec + every 0.6 sec or less
Tracking measurement:	less than 1.3 sec + every 0.4 sec or less

Atmospheric correction	
Temperature input range:	- 30 to 60°C (in 0.1°C step)/ - 22 to 140°F (in 1°F step)
Pressure input range:	500 to 1,400 hPa (in 1hPa step) 375 to 1,050 mmHg (in 1mmHg step) 14.8 to 41.3 inchHg (in 0.1inchHg step)
ppm input range:	-499 to 499 ppm (in 1 ppm step)
Prism constant correction	-99 to 99 mm (in 1 mm step) 0mm fixed for reflectorless measurement
Earth curvature and refraction correction	
	No/Yes K=0.14/Yes K=0.20 (selectable)
Sea level correction	No/Yes (selectable)

- *1 : Slight haze, visibility about 20 km, sunny periods, weak scintillation.
- *2 : No haze, visibility about 40 km, overcast, no scintillation.
- *3 : Figures when both the elevation and depression angles of the laser beam are within 15° and the instrument is facing the 360° Prism.
- *4 : Figures when the laser beam strikes within 30° of the reflective sheet target.
- *5 : Figures when using Kodak Gray Card White side (reflection factor 90%) and brightness level is less than 5,000 lx.
- *6 : Figures when using Kodak Gray Card White side (reflection factor 90%) and brightness level is less than 500 lx.
- *7 : Face the target toward the prism during the measurement with the distance at 10 m or less.
- *8 : Accuracy is (5 + 2 ppm X D) mm for distance range 0.3 to 0.66m.
- *9 : Figures will change depending on the target reflection factor, weather conditions and location conditions.

Auto Tracking (Auto Tracking model only)

Measuring method	Pulse laser transmitter and image detector with co-axial optics
Signal source (emitted beam)	infrared laser diode (980nm) Class 1 (IEC60825-1 Ed. 2.0: 2007/FDA CDRH 21 CFR Part 1040.10 and 1040.11 (Complies with FDA performance standards for laser products except for deviations pursuant to Laser Notice No.50, dated June 24, 2007.))
Viewing angle	± 45°
Measuring range	V: Elevation angle 90° (when handle is attached: 70°) , Depression angle 41°*10
Maximum Auto Tracking measurement range*11	
360° Prism ATP1/ATP1S:	2 to 600 m (1,960 ft)*3
Prism-5:	1.3 to 600 m (1,960 ft)
Prism-2:	1.3 to 1,000 m (3,280 ft)
Auto Tracking speed*11	20°/sec (Prism moving at 5m/sec. at 20m distance)

Auto Pointing

Measuring method	Pulse laser transmitter and image sensor with co-axial optics
Signal source (emitted beam)	infrared laser diode (980 nm)
	Class 1 (IEC60825-1 Ed. 2.0: 2007/FDA CDRH 21 CFR Part 1040.10 and 1040.11 (Complies with FDA performance standards for laser products except for deviations pursuant to Laser Notice No.50, dated June 24, 2007.))
Viewing angle	± 45'
Measuring range	H: 360° (full transit) V: Elevation angle 90° (when handle is attached: 70°), Depression angle 41°*10
Auto Pointing measurement range*11	
360° Prism ATP1/ATP1S:	2 to 600 m (1,960 ft)*3,14
Prism-5:	1.3 to 600 m (1,960 ft)
Prism-2:	1.3 to 1,000 m (3,280 ft)
Reflective sheet RS10/30/50:5	to 50 m (160 ft)*12,*13
Reflective sheet RS90N-K:	10 to 50 m (160 ft)*12,*13
Time to completed Auto Pointing*11	(When prism in field-of-view, at 100 m distance)/(using RS90N-K, at 50 m distance) 4 to 8 sec.
Sighting accuracy (standard deviation)*11 (fine measurement)	
Prism:	1.2 mm or less (equivalent angle) (to 100 m), (0.3 + 9ppm X D) or less (equivalent angle) (100 m and over)
Reflective sheet RS90N-K:	2 mm or less (equivalent angle)*12,*13
*10 :	Measuring time may be longer around elevation angle 90°, because the tilt compensation is not in operation.
*11 :	No haze, visibility over 20 km, slightly overcast (less than 30000 lx), no scintillation.
*12 :	When using a reflective sheet for Auto Pointing, the size of sheet (10 to 90 mm) must be selected to correspond to the distance being measured. Use smaller reflective sheets for shorter distances.
*13 :	Figures when the Auto Pointing beam strikes within 15° of the reflective sheet target.
*14 :	Figures when the Auto Pointing beam strikes within elevation and depression angle 15° of the 360° prism.

Motor

Type	DC motor drive
Motion range	360°(Vertical and horizontal)
Rotation speed	85°/sec (at 20°C) (Rotating time: about 7 sec. (when rotating 180°, tilt compensation off, at 20°C))
Fine motion	Jogs

Guide Light

Light source	LED (red 626 nm/green 524 nm)
Distance	1.3 to 150m ^{*1}
Visible range	Right and Left/Upward and Downward:± 4° (7m/100m)
Resolving power at center area (width)	4' (about 0.12/100m)
Brightness	3 levels (bright/normal/dim)

Internal memory

Capacity	500 MB (includes memory for program files)
----------	--

External memory

USB flash memory (up to 8 GB)

Data transfer

Data input/output	Asynchronous serial, RS232C compatible
USB	USB Ver. 1.1, Host (Type A) and Client (Type miniB)

Handle (Remote Control System Beam Detector)

Operable range (Slope distance when using RC-5R under normal atmospheric conditions^{*1})

Standard mode	2 ^{*15} to 100 m ^{*16}
Far mode	2 ^{*15} to 250 m ^{*17} 2 ^{*15} to 300 m ^{*16}

Maximum detecting area (vertical angle)

±30° (on the basis of horizontal direction)

Remote Control System Turning operation time (RC-5R)

About 15 sec (until completion of rapid (single) measurement)

***15** : When there is almost no vertical interval between instrument height and the target height, the instrument height is 1.5 m, target height is 0.10 m at a horizontal distance of 1.8 m

***16** : When the vertical interval between PS and the beam emitter of Remote Controller is no more than 20 m

***17** : When the vertical interval between PS and the beam emitter of Remote Controller is no more than 40 m

Bluetooth wireless communication (option)

Transmission method	FHSS
Modulation	GFSK
Frequency band	2.402 to 2.48GHz
Bluetooth profile	SPP, DUN
Power class	Class 1
Usable range	to 600m (good communication condition) ^{*18} to 300m (normal communication condition) ^{*19}
Authentication	Yes/No (selectable)

***18** : Paired with RC-5R, with instrument height to be more than 1.5m, no obstacles (like building structures, trees or vehicles) causing interrupting/reflecting radio wave, few sources of radio emissions/interference in the near vicinity of the instrument, no rain

***19** : Paired with RC-5R, located at a general residential/urban area, few sources of radio emissions/interference in the near vicinity of the instrument, no rain

Power Supply

Power source	Rechargeable Li-ion battery BDC70
Working duration at 20 °C	(Fine distance measurement (single) using Auto Pointing, repeated every 30 sec)
	BDC70: about 4hours
	BT-73Q (external battery, optional accessory): about 14.5 hours
	(After continuous Auto Tacking/tracking distance measurement)
	BDC70: about 4hours
	BT-73Q (external battery, optional accessory): about 12 hours
Battery state indicator	4 levels
Auto power-off	5 levels (5/10/15/30 min/Not set) (selectable)
External power source	6.7 to 12V

Battery (BDC70)

Nominal voltage:	7.2V
Capacity:	5,240 mAh
Dimensions:	38 (W) x 70 (D) x 40 (H) mm
Weight:	about 195g

Charger (CDC68)

Input voltage:	AC100 to 240V
Charging time per battery (at 25°C):	
BDC70:	about 5.5 hours (Charging can take longer than the times stated above when temperatures are either especially high or low.)
Charging temperature range:	0 to 40°C
Storage temperature range:	-20 to 65°C
Size:	94 (W) X 102 (D) X 36 (H) mm
Weight:	about 170g

General

Operating system	Windows Embedded CE 6.0
Display	3.5 inch Transmissive TFT QVGA color LCD
Backlight:	LED: 9 brightness levels (0 to 8) (selectable)
Touch panel:	Resistance-sensitive analog type
Keyboard	25 keys
	Key backlight: Yes
Trigger key	Yes (right side)
Sensitivity of levels	
Circular level:	10 $\frac{1}{2}$ mm
Electronic Circular levels:	Graphic display range: 6' (inner circle) Digital display range: $\pm 6'$ 30"
Optical plummet	
Image:	Erect
Magnification:	3X
Minimum focus:	0.5 m
Calendar/clock function	Yes
Laser-pointer function	ON/OFF (selectable)
Operating temperature:	-20 to 50 °C (-4 to 122 °F)
Storage temperature range	-30 to 70°C (-22 to 158 °F) (no condensation)
Dust and water resistance	IP65 (IEC 60529:2001)
Instrument height:	196mm from tribrach mounting surface
Size (with handle):	230 (W) X 207 (D) X 393 (H) mm
Weight	7.0kg (15.4lb) (with BDC70 and Handle)

27.EXPLANATIONS

27.1 High Accuracy with the 360° Prism

Sighting can be more accurately performed by facing the 360° Prism toward the instrument. The 360° Prism should be set up so that a pair of diametrically-opposed hexagonal points on its rubber flanges are aligned with the sighting direction of the instrument (see the diagram below).

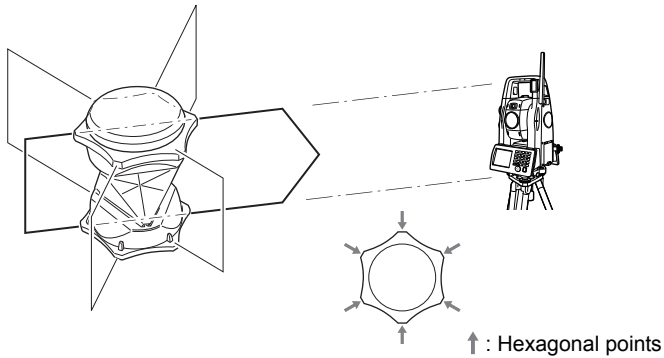

When using the ATP1S, the 360° Prism should be set up so that a pair of diametrically-opposed marks on top of the prism are aligned with the sighting direction of the instrument.

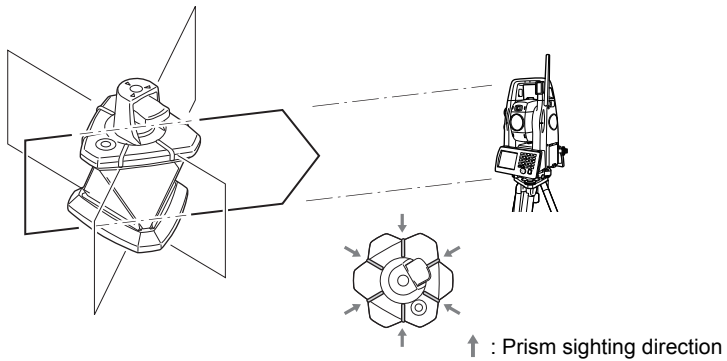

27.2 Manually Indexing the Vertical Circle by Face Left, Face Right Measurement

The 0 index of the vertical circle of your instrument is almost 100% accurate, but when it is necessary to perform particularly high precision angle measurements, you can eliminate any inaccuracy of the 0 index as follows.



- If the power is cut off, the vertical circle indexing is ineffective. Do it again every time the power is turned on.

PROCEDURE

1. Select "Obs.condition" in <Configuration>. Set "V manual" (vertical circle indexing method) to "Yes".
 "20.1 Observation Conditions"

<V manual 0 set> is displayed.

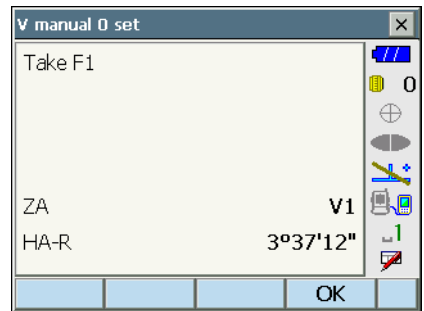

2. Carefully level the instrument.
3. Accurately sight a clear target with a distance of about 30m in the horizontal direction with the telescope in face left.
 Press **[OK]**. The vertical angle V2 is displayed under "Take F2".

4. Turn the upper part through 180° and clamp it. Then set the telescope in the face right position and accurately sight the same target.
 Press **[OK]**.
 The vertical and horizontal angles are displayed.
 This concludes the vertical circle indexing procedure.

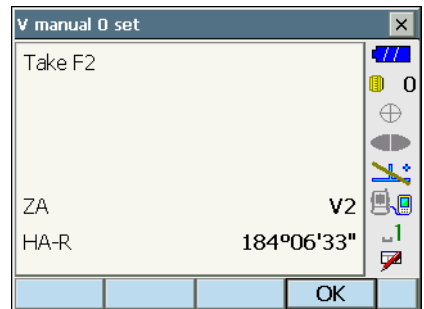



28.REGULATIONS

Compliance with Environmental Directives & Regulations

Region/ Country	Directives/ Regulations	Labels/Declarations
California, U.S.A.	Proposition 65	<div style="border: 1px solid black; padding: 5px;"> <p>WARNING : Handling the cord on this product or cords associated with accessories sold with this product, will expose you to lead, a chemical known to the State of California to cause birth defects or other reproductive harm. <i>Wash hands after handling.</i></p> </div>
California, U.S.A.	Perchlorate Material (CR Lithium Battery)	<div style="border: 1px solid black; padding: 5px;"> <p>This product contains a CR Lithium Battery which contains Perchlorate Material-special handling may apply. See http://www.dtsc.ca.gov/hazardouswaste/perchlorate/ Note ; This is applicable to California, U.S.A. only</p> </div>
California and NY, U.S.A.	Recycling Batteries	<div style="border: 1px solid black; padding: 10px;"> <p style="text-align: center;"><u>DON'T THROW AWAY RECHARGEABLE BATTERIES, RECYCLE THEM.</u></p> <p style="text-align: center;"><u>Topcon Positioning Systems Inc., United States Return Process for Used Rechargeable Nickel Metal Hydride, Nickel Cadmium, Small Sealed Lead Acid, and Lithium Ion, Batteries</u></p> <p>In the United States Topcon Positioning Systems Inc., has established a process by which Topcon customers may return used rechargeable Nickel Metal Hydride(Ni-MH), Nickel Cadmium(Ni-Cd), Small Sealed Lead Acid(Pb), and Lithium Ion(Li-Ion) batteries to Topcon for proper recycling and disposal. Only Topcon batteries will be accepted in this process.</p> <p>Proper shipping requires that batteries or battery packs must be intact and show no signs of leaking. The metal terminals on the individual batteries must be covered with tape to prevent short circuiting and heat buildup or batteries can be placed in individual plastic bag. Battery packs should not be disassembled prior to return.</p> <p>Topcon customers are responsible for complying with all federal, state, and local regulations pertaining to packing, labeling, and shipping of batteries. Packages must include a completed return address, be prepaid by the shipper, and travel by surface mode. <u>Under no circumstance should used/recyclable batteries be shipped by air.</u></p> <p>Failure to comply with the above requirements will result in the rejection of the package at the shipper's expense.</p> <p>Please remit packages to: Topcon Positioning Systems, Inc. C/O Battery Return Dept. 150 7400 National Dr. Livermore, CA 94551</p> <p style="text-align: center;"><u>DON'T THROW AWAY RECHARGEABLE BATTERIES, RECYCLE THEM.</u></p> </div>
EU	WEEE Directive	<div style="border: 1px solid black; padding: 10px;"> <div style="display: flex; align-items: center;">  <p>WEEE Directive This symbol is applicable to EU members states only.</p> </div> <p>Following information is only for EU-member states: The use of the symbol indicates that this product may not be treated as household waste. By ensuring this product is disposed of correctly, you will help prevent potential negative consequences for the environment and human health, which could otherwise be caused by inappropriate waste handling of this product. For more detailed information about the take-back and recycling of this product, please contact your supplier where you purchased the product or consult.</p> <p style="text-align: right;">TOPCON CORPORATION</p> </div>

Region/ Country	Directives/ Regulations	Labels/Declarations
EU	EU Battery Directive	 <p>EU Battery Directive This symbol is applicable to EU members states only. Battery users must not dispose of batteries as unsorted general waste, but treat properly.</p>

Compliance with Electric Directives & Regulations

Region/ Country	Directives/ Regulations	Labels/Declarations
Europe	EMC-Class B R&TTE- Class 2	 <p>EMC NOTICE In industrial locations or in proximity to industrial power installations, this instrument might be affected by electromagnetic noise. Under such conditions, please test the instrument performance before use.</p>
Europe	R&TTE- Class 2	<p>R&TTE Directive</p> <p>PS series</p> <p>Hereby, TOPCON CORP., declares that the above-mentioned equipment is in compliance with the essential requirements and other relevant provisions of Directive 1999/5/EC.</p> <p>Please inquire below if you wish to receive a copy of Topcon's Declaration of Conformity.</p> <p>Topcon Europe Positioning B.V. Essebaan 11, 2908 LJ Capelle a/d IJssel, The Netherlands Tel: +31-10-4585077 Fax: +31-10-2844949 http://www.topcon-positioning.eu/index.asp</p>
Australia	C-Tick	

Region/ Country	Directives/ Regulations	Labels/Declarations
U.S.A.	FCC-Class A	<p>FCC Compliance</p> <p>WARNING: Changes or modifications to this unit not expressly approved by the party responsible for compliance could void the user's authority to operate the equipment.</p> <p>NOTE: This equipment has been tested and found to comply with the limits for a Class A digital device pursuant to Part 15 of the FCC Rules. These limits are designed to provide reasonable protection against harmful interference when the equipment is operated in a commercial environment. This equipment generates, uses, and can radiate radio frequency energy and, if not installed and used in accordance with the operator's manual, may cause harmful interference to radio communications. Operation of this equipment in a residential area is likely to cause harmful interference in which case the user will be required to correct the interference at his own expense.</p> <p>This transmitter must not be co-located or operated in conjunction with any other antenna or transmitter.</p> <p>This equipment complies with FCC radiation exposure limits set forth for uncontrolled equipment and meets the FCC radio frequency (RF) Exposure Guidelines in Supplement C to OET65. This equipment has very low levels of RF energy that is deemed to comply without maximum permissive exposure evaluation (MPE). But it is desirable that it should be installed and operated with at least 20cm and more between the radiator and person's body (excluding extremities: hands, wrists, feet and ankles).</p> <p>Declaration of Conformity</p> <p>Model Number: PS series Trade Name: TOPCON CORPORATION</p> <p>Manufacture</p> <p>Name: TOPCON CORPORATION Address: 75-1, Hasunuma-cho, Itabashi-ku, Tokyo, 174-8580 JAPAN 243-0036 Country: JAPAN</p> <p>U.S.A. Representative</p> <p>Responsible party: TOPCON POSITIONING SYSTEMS, INC. Address 7400 National Drive Livermore, CA94551, U.S.A Telephone number: 925-245-8300</p> <p>Means of conformity This device complies with part 15 of the FCC Rules, Operation is subject to the following two conditions: (1) This device may not cause harmful interference, and (2) this device must accept any interference received, including interference that may cause undesired operation.</p>

Region/ Country	Directives/ Regulations	Labels/Declarations
Canada	ICES-Class A	<p>This Class A digital apparatus meets all requirements of Canadian Interference-Causing Equipment Regulations. Cet appareil numérique de la Class A respecte toutes les exigences du Règlement sur le matériel brouilleur du Canada.</p> <p>This class A digital apparatus complies with Canadian ICES-003. Cet appareil numérique de la classe A est conforme à la norme NMB-003 du Canada.</p> <p>Operation is subject to the following two conditions: (1) this device may not cause interference, and (2) this device must accept any interference, including interference that may cause undesired operation of this device.</p> <p>This equipment complies with IC radiation exposure limits set forth for uncontrolled equipment and meets RSS-102 of the IC radio frequency (RF) Exposure rules. This equipment should be installed and operated with at least 20cm and more between the radiator and person's body (excluding extremities: hands, wrists, feet and ankles).</p>

29.INDEX

A	
ACK mode	42
Adjusting backlight brightness/turning the reticle illumination and key backlight ON/OFF ...	121
Atmospheric correction factor	124
AUTO AIM	52
Automatic tilt angle compensation mechanism	119
B	
<i>Bluetooth</i> connections	41
<i>Bluetooth</i> device address	44
C	
Cold boot	39
Collimation correction	119
Color setting	122
D	
Date and Time	138
E	
EDM ALC	122
Eliminating parallax	56
F	
Fixed velocity rotation	67
G	
Guide light	10
H	
Hdist	118
Horizontal angle settings	79, 85
Horizontal jog	11
I	
Inch (Fraction of an inch)	136
Instrument height mark	10
K	
Key backlight	122
L	
Laser-pointer function	10
Laser-pointer off	122
Lost Prism	62
M	
Measure Acc.	53
P	
Power-saving automatic cut-off/Backlight Off	121
Precaution when performing resection	90
Prism constant correction value	123
Problems Powering OFF	40
Power-saving automatic cut-off (Power on command)	121

R	
Resection calculation process	89
Resume function	38
S	
Sea level correction	119
Search operation during Auto pointing	53
Search pattern	54
Sighting collimator	11
Sighting manually	57
Slope area	113
Srch method	53
T	
Terminate	42
Trigger key	11
Turning operation	63
TURN	53
V	
V mode (vertical angle display method)	119
Vertical Jog	11

TOPCON CORPORATION

75-1 Hasunuma-cho, Itabashi-ku, Tokyo 174-8580, Japan <http://www.topcon.co.jp>

Please see the attached address list or the following website for contact addresses.

GLOBAL GATEWAY <http://global.topcon.com/>
